

**SIMRAD**

**BSM-3**

Installation Manual

ENGLISH





# Preface

---

## Disclaimer

As Navico is continuously improving this product, we retain the right to make changes to the product at any time which may not be reflected in this version of the manual. Please contact your nearest distributor if you require any further assistance.

It is the owner's sole responsibility to install and use the instrument and transducers in a manner that will not cause accidents, personal injury or property damage. The user of this product is solely responsible for observing safe boating practices.

NAVICO HOLDING AS AND ITS SUBSIDIARIES, BRANCHES AND AFFILIATES DISCLAIM ALL LIABILITY FOR ANY USE OF THIS PRODUCT IN A WAY THAT MAY CAUSE ACCIDENTS, DAMAGE OR THAT MAY VIOLATE THE LAW.

Governing Language: This statement, any instruction manuals, user guides and other information relating to the product (Documentation) may be translated to, or has been translated from, another language (Translation). In the event of any conflict between any Translation of the Documentation, the English language version of the Documentation will be the official version of the Documentation.

This manual represents the product as at the time of printing. Navico Holding AS and its subsidiaries, branches and affiliates reserve the right to make changes to specifications without notice.

## Trademarks

NMEA 2000 is a registered trademark of the National Marine Electronics Association.

Navionics is a registered trademark of Navionics SpA.

Simrad is a trademark of Kongsberg Maritime AS Company registered in the US and other countries and is being used under license.

B&G, Lowrance, StructureScan, Navico, SonicHub, SimNet, Skimmer, InsightHD, Broadband Radar, Broadband Sonar, and SonarHub are trademarks of Navico, registered in the US and other countries.

## Copyright

Copyright © 2014 Navico Holding AS.

## Warranty

The warranty card is supplied as a separate document.

In case of any queries, refer to the brand web site of your display or system: [www.simrad-yachting.com](http://www.simrad-yachting.com)

## Declarations and conformance

This equipment is intended for use in international waters as well as coastal sea areas administered by countries of the E.U. and E.E.A.

## Compliance Statements

BSM-3:

- Comply with CE under EMC directive 2004/108/EC
- Comply with the requirements of level 2 devices of the Radiocommunications (Electromagnetic Compatibility) standard 2008/tra es

The relevant Declaration of Conformity is available in the following website, under the model documentation section:

[www.simrad-yachting.com](http://www.simrad-yachting.com)

## Warning

The user is cautioned that any changes or modifications not expressly approved by the party responsible for compliance could void the user's authority to operate the equipment.

This equipment has been tested and found to comply with the limits for a Class B digital device, pursuant to Part 15 of the FCC rules. These limits are designed to provide reasonable protection against harmful interference in a residential installation. This equipment generates, uses and can radiate radio frequency energy and, if not installed and used in accordance with the instructions, may cause harmful interference to radio communications. However, there is no guarantee that the interference will not occur in a particular installation. If this equipment does cause harmful interference to radio or television reception, which can be determined by turning the equipment off and on, the user is encouraged to try to correct the interference by one or more of the following measures:

- Reorient or relocate the receiving antenna
- Increase the separation between the equipment and receiver
- Connect the equipment into an outlet on a circuit different from that of the receiver
- Consult the dealer or an experienced technician for help.



## About this manual

This document describes how to install the BSM-3 and connect the unit to transducers and display units.

Separate installation instruction for transducers are included with the transducer package.

The BSM-3 is compatible with the following MFD displays and systems:

- NSE
- NSO, NSO evo2
- NSS, NSS evo2

<http://support.simrad-yachting.com>

→ **Note:** Make sure the MFD has up-to-date software, - refer to the website: [www.simrad-yachting.com](http://www.simrad-yachting.com)

Important text that requires special attention from the reader is emphasized as follows:

→ **Note:** Used to draw the reader's attention to a comment or some important information.



**Warning:** *Used when it is necessary to warn personnel that they should proceed carefully to prevent risk of injury and/or damage to equipment/personnel.*

# Contents

---

<b>7</b>	<b>Introduction</b>
7	BSM-3 module layout
7	Parts included in package
<b>9</b>	<b>Installation and wiring</b>
9	Mounting location
10	Securing BSM-3 module
11	Wiring
12	Connecting the BSM-3 to your display
<b>13</b>	<b>Transducer connection</b>
13	BSM-3 connectors
14	Transducer with a 7-pin connector
14	Transducer with bare wires
15	Airmar transducers
<b>18</b>	<b>Trouble shooting</b>
<b>19</b>	<b>Technical specification</b>
<b>21</b>	<b>Dimensional drawings</b>
<b>22</b>	<b>Spare parts and accessories</b>
22	Spare parts
22	Accessories
22	Transducers

# 1



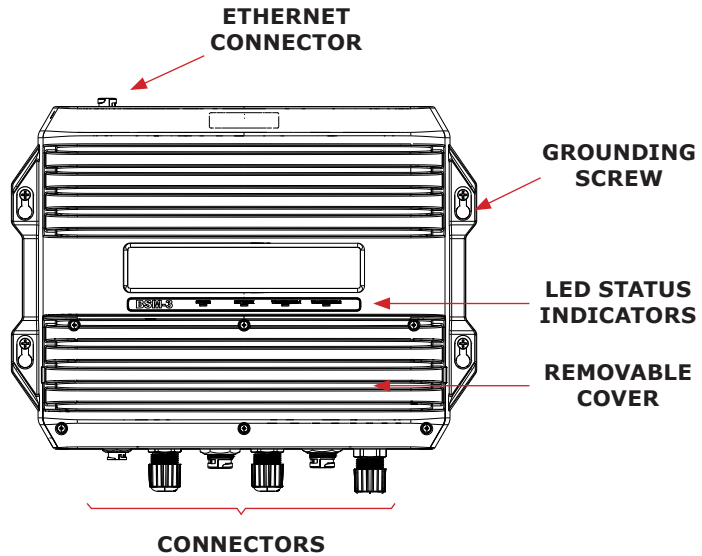

## Introduction

### BSM-3 module layout

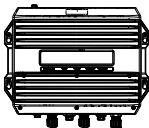

### Parts included in package

For spare parts and part numbers, see “Spare parts and accessories” on page 22.

Item	No.	Description
	1	BSM-3 sounder module
	1	Ethernet cable, 1.8 m (6 ft)
	1	Power cable (bare wires), 2 m (6.5 ft)
		Cable glands for bare wire transducer installation

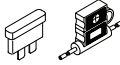
Item	No.	Description
	4	Screws
	1	Spare Fuse kit including; 3A Fuses and fuse holders
	1	Warranty card
	1	This manual

### Required tools and supplies

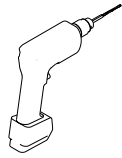

Drill



2 mm  
(5/64")  
Drill Bit

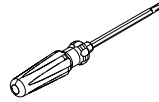

Screw driver

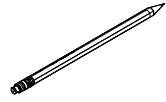

Pencil

# 2

## Installation and wiring

### Mounting location

Before installing the BSM-3, consider location and cable runs necessary to connect the module to display unit, transducer and power source.

The mounting location must allow for required working area when connecting the cables. Also ensure that the location allows viewing the unit's LED indicators.

The units should be mounted with special regard to the units' environmental protection, temperature range and cable length.

The mounting surface needs to be structurally strong, with as little vibration as possible. If possible, mount the unit close to the edges of a panel to minimize vibration.

Do not run the transducer cabling near the BSM-3 power cables, any VHF antenna coax cables or any DC or AC power cables. Avoid placing Ethernet cables close to VHF antennas.

The BSM-3 conforms to the appropriate Electromagnetic Compatibility (EMC) standards, but proper installation is required to get best use and performance from this product. Ensure you have as much separation as possible between different electrical equipment, (see diagram below).

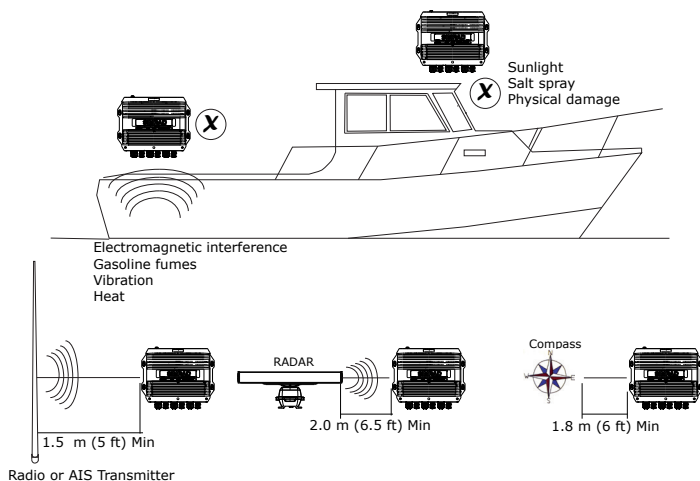

## Securing BSM-3 module

Mount the BSM-3 on a vertical surface with the power and transducer cable connections exiting downwards.

Fasten the BSM-3 by using the 4 stainless steel self tapping screws included with the unit.

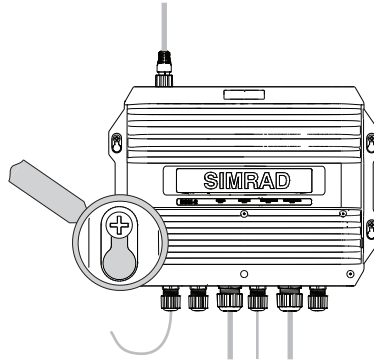

## Wiring

The BSM-3 has convenient connectors to attach power and transducers. It is also supplied with cable glands to allow for transducers that don't have a 7 pin connector.



**The BSM-3 contains high voltages and specialized parts; the operator should never remove the module's cover without removing the power connection.**



**Removing the transducer cable from the BSM-3 while the module is powered on can cause sparks. Remove the transducer cables only after the module has been disconnected from its power source.**

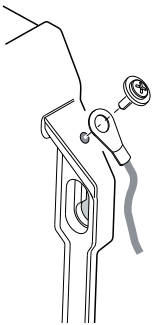

## Grounding the unit

For additional safety install grounding cable in ground screw hole as indicated on illustration. Recommended 16 awg wire.

## Power

The unit has no power key and will turn on when power is applied. When used in an NSE/NSS/NSO evo2 system, it is recommended to connect the BSM-3 to the Power control bus, and set display system to power control master.

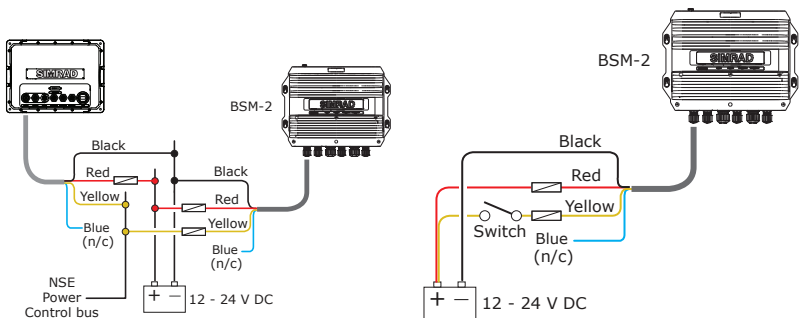

If the BSM-3 is connected directly to the vessel's battery, the module will continue to draw power even when it is not in operation. It is recommended that the yellow power cable wire be fitted with an optional on/off switch, allowing the BSM-3 to be powered off when not in use.

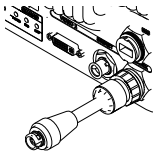

## Connecting the BSM-3 to your display

The BSM-3 connects to your display system over an Ethernet network, either directly or via a Network Expansion Port.

When connected to an NSO, the RJ45 to 5 pin cross-over Ethernet cable included with the NSO system must be used.

→ **Note:** Above not relevant to NSO evo2

For details refer to the display system's Installation manual.

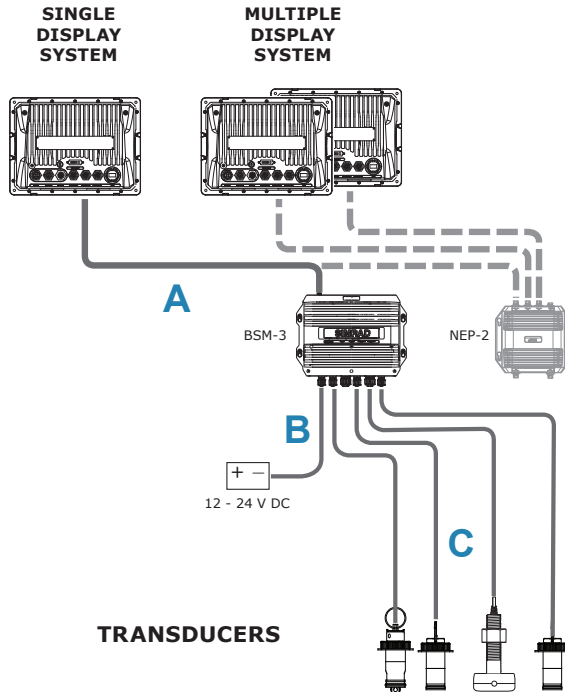

Ref	Description
A	Ethernet cable
B	BSM-3 Power cable
C	Transducer cables



# 3

## Transducer connection

### BSM-3 connectors

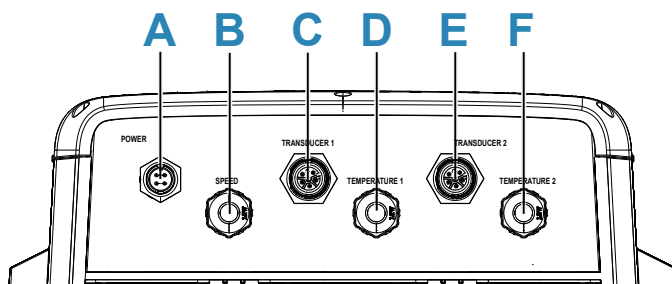

Ref	Description
A	Power 12 or 24 V DC (9-32 V DC) 4 pin connector
B	Speed Input
C	Transducer port 1 : 7 pin blue connector: Connect medium or high frequency transducers.
D	Cable gland for independent temperature input: Tied to Transducer 1
E	Transducer port 2 : 7 pin blue connector: Connect low frequency transducers
F	Cable gland for independent temperature input: Tied to Transducer 2

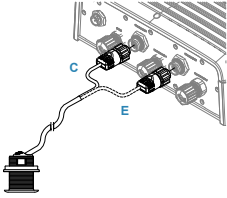

## Transducer with a 7-pin connector

Most Airmar transducers as of 2014 are available with 7-pin blue connectors including dual channel transducers. These connect to the corresponding connectors on the BSM-3. Dual channel transducers will have two connectors and will be labeled.

## Transducer with bare wires

### Remove connectors

1. Remove cover.

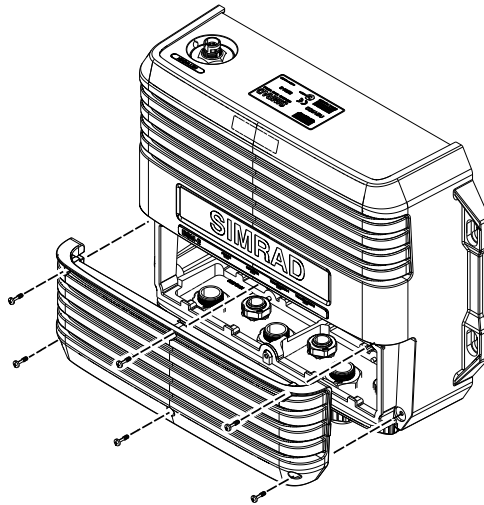

2. Remove terminal blocks and disconnect the connector wires for both transducer ports including wires going to temperature and speed terminals.
3. Remove connector lock nut and remove connector.

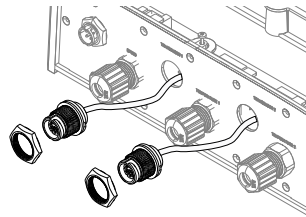
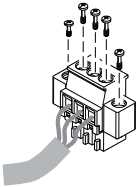

4. Select cable inlets according to cable diameter and labelling on the front plate.
5. Disassemble the appropriate cable gland, and thread the gland parts on to the cable.

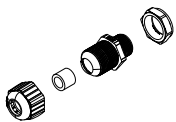

6. Insert the gland housing in to the BSM-3 case and secure with nut.

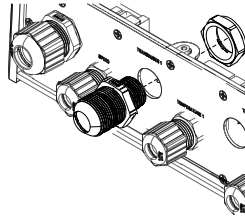

7. Pass the gland securing nut over the bare wires and along the cable.

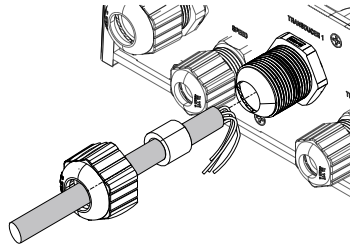

8. Pass the cable through the gland housing.
9. Terminate the wires to the terminal blocks according to the terminal specification in the following pages
10. Connect the terminal blocks to the corresponding connector block
11. Tighten the cable gland outer sealing nuts by hand
12. Close the BSM-3 cover and secure the cables.

Port	Gland size	Cable diameter
Transducer 1&2	M20	10.0 mm - 14.0 mm (3.94" - 5.51")
Power Speed Temperature 1 Temperature 2	M16	6.0 mm - 10.0 mm (2.36" - 3.94")

## Airmar transducers

The wiring diagram below shows how to connect an Airmar transducer (B265).

- **Note:** On some models Low frequency XDRC+ wire (blue/white) can be yellow.

On some transducer models temperature brown cable is connected internally to XID GND, and there is no need to connect bare and brown cable together.

Consult XDCR documentation for correct wiring diagram before connecting transducer!

Ref	Color	Function
A	Orange	XID
B	Shield	XID ground (if available)
C	Brown	Thermistor (XID ground)
D	White	Thermistor
E	Shield	High freq. depth shield
F	Black	High freq. negative
G	Blue	High freq. positive
H	Orange	XID *
I	Brown	Thermistor (XID ground) *
J	Shield	Low freq. depth shield
K	Black and white (or black)	Low freq. negative
L	Blue/white or yellow	Low freq. positive

\* Dual transducer installation only

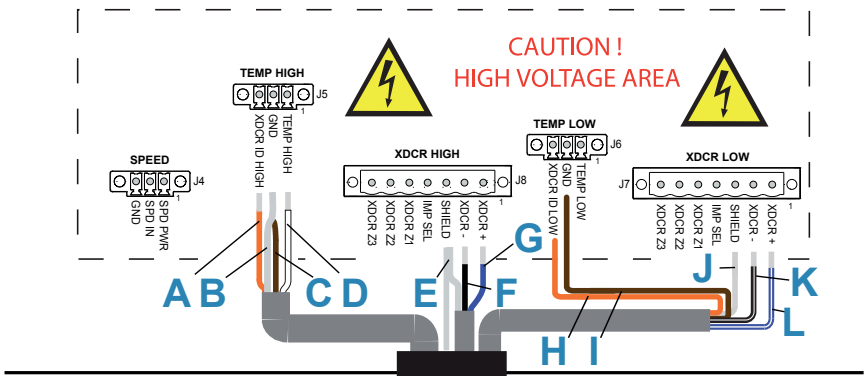

## Setting up the transducers

The BSM-3 is compatible with Airmar's Transducer ID protocol. If you have an Airmar transducer that supports this feature, BSM-3 will read your transducer's specification at start-up and automatically adjust the frequency and temperature settings. The transducer's XID wire (orange) should be connected to the XDCR\_ID\_HIGH/LOW terminal in the TEMP HIGH/LOW connector as shown below.

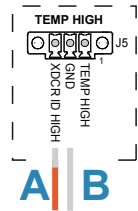

Ref	Color	Signal
A	Orange	XID
B	Shield	XID GND

If your transducer doesn't support Airmar's Transducer ID protocol, the transducer selection and configuring needs to be done from the display as shown on the graphics below.

A detailed description is found in the relevant documentation for the display.

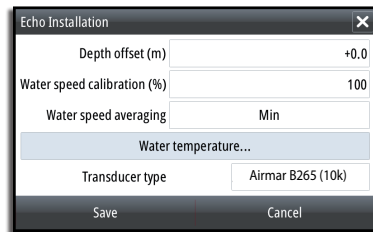
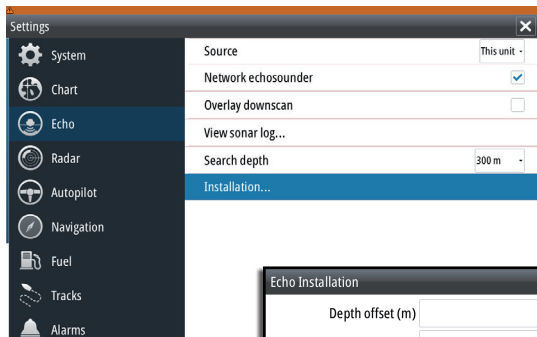

# 4

## Trouble shooting

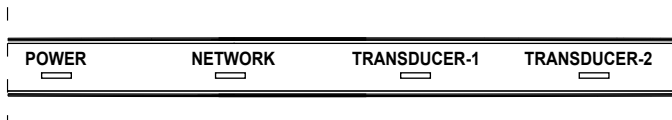
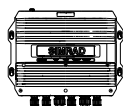

Ind.	Status	Description
Power	Off	No power connection Check power and power cable Check yellow wire
	On - Red	System starting
	On - Green	System operational
	Flashing - Red/Green	Software error or unit reprogrammed Restart the unit If still not ok, contact Customer Support
Network	Off	No Ethernet connection Check cable Verify that remote unit is turned ON
	On - Green	Ethernet connected and ok
Transducers	Off	Transducer not connected
	Flashing every 0.5 second - Green	Initializing transmitter
	Flashing every second - Green	Searching for bottom signal
	On - Green	System operational

# 5

## Technical specification

Compliance and environmental	
Compliance	CE, C-TICK
Technical standards	IEC 60945, IEC 60529
Waterproof	IPX5
Humidity	Up to 95% at 35°C non-condensing
Storage temperature	-30°C to +70°C
Operating temperature	-15°C to +55°C
General	
Connectors	6 Glands and 1 Ethernet
Weight	4.8 kg (10.6 lbs)
Dimensions (WxHxD) mm/ in	340x100x289 mm (13.38x3.94x11.37 inches)
Mounting	4 keyholed mounting tabs
Power requirements	
Power consumption	Range dependent – normally less than 10 W
Sonar specifications	
Power output	250 Watts RMS 2,000 Watts (peak to peak)
Frequencies	Broadband Frequencies Transceiver High: 130-210 kHz; 85-145 kHz Broadband Frequencies Transceiver Low: 40-60 kHz; 25-45 kHz Narrowband Frequencies Transceiver High: 200 kHz; 83 kHz Narrowband Frequencies Transceiver Low: 50 kHz; 38 kHz; 28 kHz
Transmitter and receiver type	Dual Broadband tuned receivers Dual tuned CHIRP transmitters

Pulse Length	Range Dependent - to 70 ms max
Max. transmit rate	Range dependent – to 20 Hz in shallow depths. User selectable.
Range scales	5, 8, 10, 15, 20, 30, 40, 60, 80,100,120, 150, 200, 250, 300, 400, 500, 600, 700, 800, 900, 1000, 1500, 2000, 4000, 6000, 8000, 10,000, 12,000, 15,000 → <b>NOTE: all numbers above in ft. can be changed to metrics in NSE/NSO/NSS unit.</b>
Range control	Auto/manual range with zoom, alternating dual frequency display with CHIRP, simultaneous with narrowband
Zoom size	Auto/manual x2, x3, x4, x5, x6, x7, x8 (user selectable)
<b>DC Voltage requirements</b>	
Voltage	10.7–32 VDC (for 12 or 24 VDC systems)
<b>Interfaces</b>	
Network	Ethernet 10/100



# 6

## Dimensional drawings

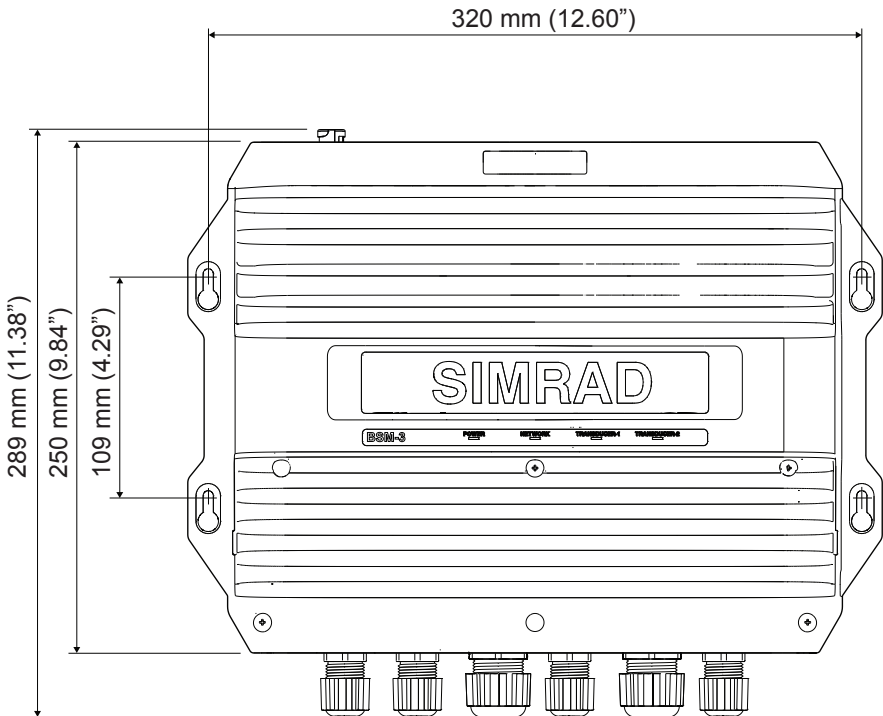
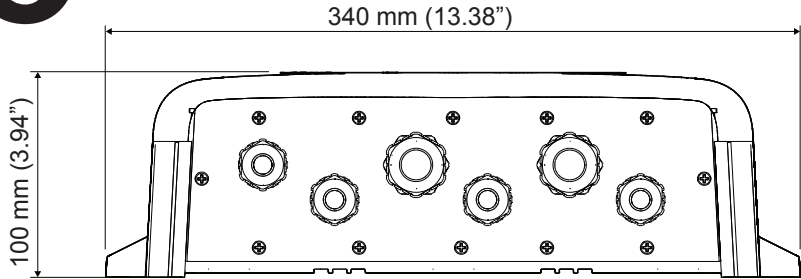

# 7

## Spare parts and accessories

### Spare parts

Part no.	Description
000-00128-001	Power cable
000-10412-001	Hardware mounting accessories including 4 screws; 8Gx1, PAN POZI, S/T, 16, LO-HEAD
000-10414-001	Terminal block
003-9558-00	Cable gland kit
003-8590-00	Fuse Kit

### Accessories

Part no.	Description
000-0127-51	Ethernet cable yellow 5 Pin 2 m (6.5 ft)
000-0127-29	Ethernet cable yellow 5 Pin 4.5 m (15 ft)
000-0127-30	Ethernet cable yellow 5 Pin 7.7 m (25 ft)
000-0127-37	Ethernet cable yellow 5 Pin 15.2 m (50 ft)
000-10029-001	NEP-2 Network Expansion Port (Yellow connectors)

### Transducers

For a full list of compatible transducers please refer to the transducer selection guide on <http://www.simrad-yachting.com/transducerguide/>





**SIMRAD**

