

SIMRAD

RS90S Blackbox VHF

User Manual

ENGLISH



Preface

Disclaimer

As Navico is continuously improving this product, we retain the right to make changes to the product at any time which may not be reflected in this version of the manual. Please contact your nearest distributor if you require any further assistance.

It is the owner's sole responsibility to install and use the equipment in a manner that will not cause accidents, personal injury or property damage. The user of this product is solely responsible for observing safe boating practices.

NAVICO HOLDING AS AND ITS SUBSIDIARIES, BRANCHES AND AFFILIATES DISCLAIM ALL LIABILITY FOR ANY USE OF THIS PRODUCT IN A WAY THAT MAY CAUSE ACCIDENTS, DAMAGE OR THAT MAY VIOLATE THE LAW.

Governing Language: This statement, any instruction manuals, user guides and other information relating to the product (Documentation) may be translated to, or has been translated from, another language (Translation). In the event of any conflict between any Translation of the Documentation, the English language version of the Documentation will be the official version of the Documentation.

This manual represents the product as at the time of printing. Navico Holding AS and its subsidiaries, branches and affiliates reserve the right to make changes to specifications without notice.

Copyright

Copyright © 2018 Navico Holding AS.

Warranty

The warranty card is supplied as a separate document.

In case of any queries, refer to the brand website of your unit or system: www.simrad-yachting.com

RF emissions statements

European Union

This RS90S complies with CE under RED Directive 2014/53/EU. The relevant Declaration of conformity is available in the product's section at the following website: www.simrad-yachting.com.

United States

Part 15 of the FCC Rules. Operation is subject to the following two conditions: (1) this device may not cause harmful interference, and (2) this device must accept any interference received, including interference that may cause undesired operation.

Warning

The user is cautioned that any changes or modifications not expressly approved by the party responsible for compliance could void the user's authority to operate the equipment.

RF Emissions notice

This equipment complies with FCC radiation exposure limits set forth for an uncontrolled environment. This device's antenna must be installed in accordance with provided instructions; and it must be operated with minimum "place number here" m spacing between the antennas and all person's body (excluding extremities of hands, wrist and feet) during operation. Further, this transmitter must not be co-located or operated in conjunction with any other antenna or transmitter.

→ **Note:** This equipment has been tested and found to comply with the limits for a Class B digital device, pursuant to Part 15 of the FCC Rules. This equipment generates, uses and can radiate radio frequency energy and, if not installed and used in accordance with the instructions, may cause harmful interference to radio communications. However, there is no guarantee that the interference will not occur in a particular installation. If this equipment does cause harmful interference to radio or television reception, which can be determined by turning the equipment off and on, the user is encouraged to try to correct the interference by one or more of the following measures:

- Reorient or relocate the receiving antenna.
- Increase the separation between the equipment and receiver.
- Connect the equipment into an outlet on a circuit different from that of the receiver is connected.
- Consult the dealer or an experienced technician for help.

Canada

This device complies with Industry Canada's licence-exempt RSSs. Operation is subject to the following two conditions:

1. This device may not cause interference; and
2. This device must accept any interference, including interference that may cause undesired operation of the device.

Le présent appareil est conforme aux CNR d'Industrie Canada applicables aux appareils radio exempts de licence. L'exploitation est autorisée aux deux conditions suivantes:

1. l'appareil ne doit pas produire de brouillage, et
2. l'utilisateur de l'appareil doit accepter tout brouillage radioélectrique subi, même si le brouillage est susceptible d'en compromettre le fonctionnement.

Industry Canada Statement

Under Industry Canada regulations, this radio transmitter may only operate using an antenna of a type and maximum (or lesser) gain approved for the transmitter by Industry Canada. To reduce potential radio interference to other users, the antenna type and its gain should be so chosen that the equivalent isotropically radiated power (e.i.r.p.) is not more than that necessary for successful communication.

Conformément à la réglementation d'Industrie Canada, le présent émetteur radio peut fonctionner avec une antenne d'un type et d'un gain maximal (ou inférieur) approuvé pour l'émetteur par Industrie Canada. Dans le but de réduire les risques de brouillage radioélectrique à l'intention des autres utilisateurs, il faut choisir le type d'antenne et son gain de sorte que la puissance isotrope rayonnée équivalente (p.i.r.e.) ne dépasse pas l'intensité nécessaire à l'établissement d'une communication satisfaisante.

This radio transmitter (RS90S) has been approved by Industry Canada to operate with the antenna types listed below with the maximum permissible gain and required antenna impedance for each antenna type indicated. Antenna types not included in this list, having a gain greater than the maximum gain indicated for that type, are strictly prohibited for use with this device.

Le présent émetteur radio (RS90S) a été approuvé par Industrie Canada pour fonctionner avec les types d'antenne énumérés ci-dessous et ayant un gain admissible maximal et l'impédance requise pour chaque type d'antenne. Les types d'antenne non inclus dans cette liste, ou dont le gain est supérieur au gain maximal indiqué, sont strictement interdits pour l'exploitation de l'émetteur.

Notice specific to the Wireless handset (HS35)

This ISM device complies with Canadian ICES-001. Maintain a minimum separation of 2.5 cm (1 inch) from the face.

Cet appareil ISM est conforme à la norme NMB-001 du Canada. Maintenir une distance minimum de 2,5 cm (1 inch) de la surface.

Australia & New Zealand

Complies with the requirements of level 2 devices of the Radiocommunications (Electromagnetic Compatibility) standard 2017 and Radiocommunications (VHF Radiotelephone Equipment – Maritime Mobile Service) Standard 2014.

Countries of intended use in the EU

AT - Austria	HU - Hungary	PL - Poland
BE - Belgium	IS - Iceland	PT - Portugal
BG - Bulgaria	IE - Ireland	RO - Romania
CY - Cyprus	IT - Italy	SK - Slovak Republic
CZ - Czech Republic	LV - Latvia	SI - Slovenia
DK - Denmark	LI - Liechtenstein	ES - Spain
EE - Estonia	LT - Lithuania	SE - Sweden
FI - Finland	LU - Luxembourg	CH - Switzerland
FR - France	MT - Malta	TR - Turkey
DE - Germany	NL - Netherlands	UK - United Kingdom
GR - Greece	NO - Norway	

Trademarks

Simrad® and Navico® are registered trademarks of Navico.

NMEA® and NMEA 2000® are registered trademarks of the National Marine Electronics Association.

Navico recommends that you check the radio operating licensing requirements of your country before using this VHF radio. The operator is solely responsible for observing proper radio installation and usage practices.

Notes on MMSI and DSC

The user MMSI (Marine Mobile Service Identity) is a unique nine digit number. It is used on marine transceivers that are capable of using DSC (Digital Selective Calling). Digital Selective Calling offers significant safety and convenience advantages over older VHF radios without this functionality.

- **Note:** Many countries do not have radio repeaters that support DSC message relaying. However DSC can still be useful for direct ship-to-ship communication, where the other vessel is also equipped with a DSC capable radio.

You must obtain a user MMSI and enter it into your radio in order to use the DSC functions. Contact the appropriate authorities in your country to obtain an MMSI number - charges may apply. If you are unsure who to contact, consult your Simrad dealer.

- **Note:** DSC distress calls generated by this radio are limited to the same range restrictions that apply to regular VHF transmissions. The vessel sending a distress can only rely upon DSC if within range of a GMDSS Coast Radio Station. Typical VHF range may be about 20NM, though this varies greatly depending upon installation, antenna type, meteorological conditions, etc.

About this manual

This manual is a reference guide for installing and operating a RS90S VHF radio. Important text that requires special attention from the reader is emphasized as follows:

- **Note:** Used to draw the reader's attention to a comment or some important information.

 **Warning:** *Used when it is necessary to warn personnel that they should proceed carefully to prevent risk of injury and/or damage to equipment/personnel.*

Contents

11 Introduction

12 Getting started

- 12 Handsets
- 15 Handset control buttons
- 16 Switching on and off
- 18 The standby screen
- 20 Modes
- 20 Changing channel
- 22 Adjusting squelch
- 22 Setting transmission power
- 23 PTT Key
- 23 Using the menus
- 23 Shortcut keys
- 24 Entering data
- 24 Warning messages
- 24 Alert tones

25 Operating procedures

- 25 Making a routine radio call
- 25 Calling a buddy
- 26 Making a channel 16/9 distress call
- 26 Making a DSC distress call
- 27 Receiving weather alerts (US model only)
- 27 Receiving SAME alerts (US model only)
- 28 Favourite channel (non-US models)
- 29 Three favourite channels 3CH
- 29 Scanning channels
- 32 Using the hailer
- 33 Using the fog horn
- 34 Using the intercom
- 34 Using the announce function
- 35 Using the voice recorder
- 35 Sharing NMEA 2000 data

36 Waypoint procedures

- 36 Adding a new waypoint

37	Editing a waypoint
37	Deleting a waypoint
38	Navigating to a waypoint
40	DSC procedures
40	Introduction to DSC
42	DSC Distress calls
45	Sending routine DSC calls
56	Receiving DSC calls
62	ATIS
63	AIS procedures
64	List of nearby vessels
64	PPI display
65	T/CPA screen
66	AIS target information
67	Installation
67	Checklist
70	Positioning
71	Installing the transceiver
72	Installing a wired handset cradle
73	Installing a handset cable connector
74	Installing a wireless handset cradle
75	External speakers installation options
77	Transceiver external connectors
77	Transceiver internal connectors
83	Setting up the radio
83	NMEA 2000 Network
85	Setup
85	Wireless handset setup
86	Buddy list setup
88	Radio setup
95	DSC Setup
102	AIS Setup
105	GPS setup
108	General setup

110 Appendices

- 110 Appendix 1 - Troubleshooting
- 111 Appendix 2 - Keys reference
- 113 Appendix 3 - Beep tones and call alerts
- 113 Appendix 4 - Warning Messages
- 113 Appendix 5 - AIS information
- 115 Appendix 6 - Technical specification
- 119 Appendix 7 - Channel charts

1

Introduction

The Simrad RS90S VHF radio is a comprehensive solution for marine VHF radio applications.

The radio comprises:

- RS90S VHF transceiver.
- One wired handset as standard, and optionally up to 3 more wired handsets. (Maximum of 4 wired handsets in total.)
- Up to 2 optional wireless handsets.
- Up to 4 optional external speakers.

In addition to routine ship-to-ship or ship-to-shore VHF communications, the RS90S has many advanced features, including:

- NMEA 2000 and NMEA 0183 network connectivity, which allows the radio to share information with other onboard devices, such as a GPS antenna, a chart plotter or a multi-function display.
- Digital Selective Calling (DSC) for automated distress calls, and for calling individual vessels using their Maritime Mobile Service Identity (MMSI). Also includes a track buddy function.
- Automatic Identification System (AIS) for monitoring nearby vessels (receive only).
- Automatic Terminal Information Service (ATIS) function for controlled VHF communications in European inland waterways (EU models).
- Automatic weather alert using TONE and SAME systems (US models).
- Monitoring multiple VHF channels simultaneously (country specific).
- Intercom calls between handsets.
- Voice recording.
- Fog horn and loud-hailer modes.
- Horn button connection.
- Up to three instant favourite channel selections.

2

Getting started



Caution: Under extreme operating conditions, the temperature of the rear heat-sink on this radio may exceed normal surface temperatures. Caution is advised to prevent possible skin burns.

Handsets

All the operating functions of the RS90S are carried out using the handsets. Each handset contains a microphone, a small internal loudspeaker and various buttons for controlling the radio.

Two types of handset are available:

- Up to four wired handsets can be connected. There must be at least one wired handset connected to the station one terminal in the installation.
- Up to two wireless handsets can be installed. The wireless handsets communicate with the transceiver by 2.4 GHz radio communication. The wireless handsets are powered by internal rechargeable batteries, and are charged by inductive charging when on the cradle.

When there are multiple handsets, they are synchronized so that there is no conflict of operation and each display the same information on their screens.

Handset naming

Handset names appear on screen at times—for example, when another handset has control of the radio.

Wired handsets HS1, HS2, HS3, HS4

The above handsets—1 standard and 3 optional—are connected to the transceiver. The volume controls on these handsets control the corresponding external speakers.

Handset parts

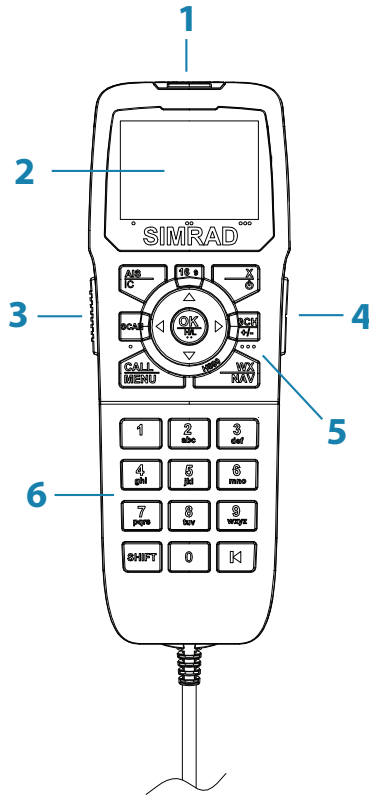

- 1 Red distress cover with button beneath
- 2 Screen
- 3 PTT button
- 4 Volume control
- 5 Function keys
- 6 Keypad (wired handsets only).

Subscribing a wireless handset

At installation time, wireless handsets must be registered in the transceiver. For instructions, see “Subscribing a wireless handset” on page 85.

Charging a wireless handset

When a wireless handset is not in use, it should be placed on its cradle for charging.

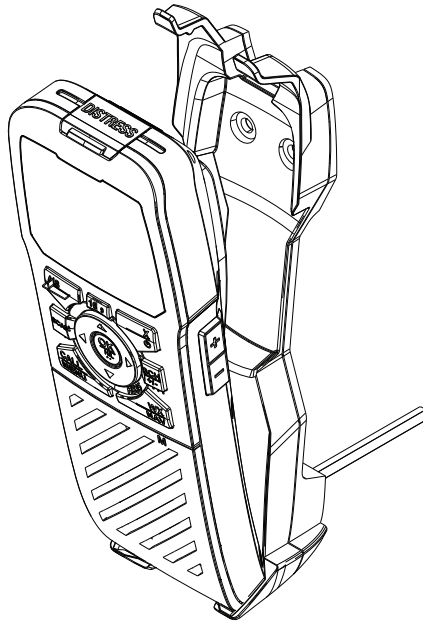

Locate the bottom of the handset onto the cradle first, and then press the top of the handset inwards until it clicks into the top lugs.

Handset operation priority

If you want to use HS1, but it displays “HS# IN USE,” it means that another handset is operating.

To shift control to HS1:

1. Press [X].
2. The display shows “Take Control?”
 - Press [OK] to take over control.
 - Or, [X] to leave the other handset in control.

Handset control buttons

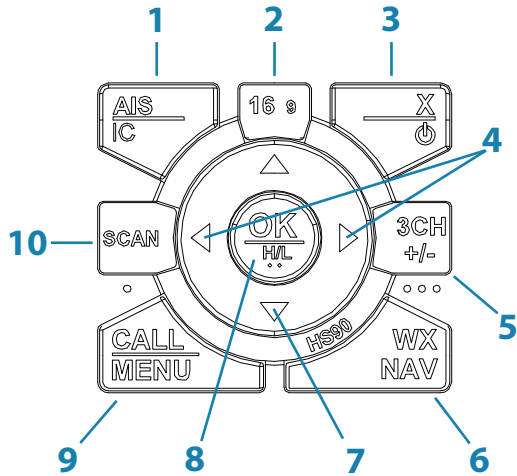

- 1 Short press for AIS menu.
Long press for Intercom / Hailer mode.
- 2 Press to select the priority channel.
- 3 Short press for Exit key.
Long press for power on/off.
- 4 Squelch keys. Also used for moving cursor left/right.
- 5 Three favourite channel key.
- 6 Short press for weather station (US models).
Long press for Navigation mode.
- 7 Change channel, or scroll menu options.
- 8 Short press for [OK] key.
Long press to toggle high/low power.
- 9 Short press for DSC menu.
Long press for menu.
- 10 Short press to start dual-watch or tri-watch mode.
Long press to start scanning channels.

For more information on keys, see “Appendix 2 - Keys reference” on page 111.

Switching on and off

Switching on the system

The VHF radio is switched on from a wired handset.

To switch on the radio:

1. Press and hold [X] on a wired handset until the startup screen showing version numbers appears.
2. When prompted, press [X] to exit the startup screen and display the main operating screen.

This switches on the transceiver and the wired handset.

- **Note:** A wireless handset can only switch itself on and off. See “Switching on a wireless handset” on page 17.

Switching off the system

The system is switched off by holding down the [X] key on a wired handset until the display shows “Release key to power off.”

Just one handset

1. In standby mode, press [X] on the wired handset until the display shows “Release key to power off.”
2. Release the [X] key.

More than one wired handset

HS1 (handset 1) has a power-off menu. All the other handsets simply power themselves off.

Handset 1 power-off menu:

- **SYSTEM**
Turns off all handsets and the transceiver.
 - **HS1**
Turns off the handset itself.
Displays “SYSTEM IS WORKING” with no backlight.
- **Note:** You can ignore the power-off menu and keep holding down [X] until the display shows “Release key to power off.”

Switching on a wireless handset

- Press and hold [X] until the display illuminates.
The display shows “Searching,” then “Connecting,” and then the current operating screen.

→ Notes:

- This only switches on the individual wireless handset, not the transceiver.
- If the transceiver is off, the wireless handset continues to display “Searching”.
- At install time, wireless handsets must be subscribed. See “Subscribing a wireless handset” on page 85.

Switching off a wireless handset

→ **Note:** This procedure only switches off the wireless handset. It does not switch off any other handsets or the transceiver.

1. Press and hold [X] until the following message appears: “Release key to power off.”
2. Release the [X] key.

Handset status display

A small icon located on the lower right of the screen shows the status of all connected handsets.

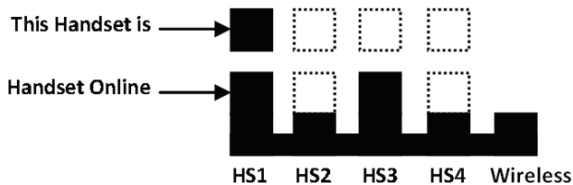

The above example shows that handset 1 and handset 3 are online and this handset is handset 1.

The standby screen



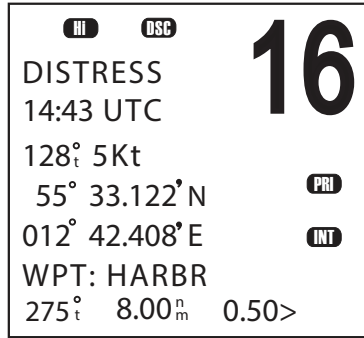

The following illustration shows a typical operating screen in standby mode. The radio is in standby mode when it is waiting to send or receive calls.



The above screen shows:

- The radio is tuned to channel 16, which has been designated as the priority channel (PRI).
- In this unit, Channel 16 has been named "DISTRESS."
- Transmitting power is set to high (Hi).
- DSC is enabled.
- The time is 14:43 UTC.
- The current course is 128° true and speed over ground is 5.0 knots.
- The current latitude is 55°33.122'N and longitude 012°42.408'E.
- The channel bank selected is International (INT).
- The name of the destination waypoint is HARBR.
- The unit selected is Nautical Miles (nm).
- The destination waypoint is 8 nm away at a bearing of 275° true.
- The current Cross-Track-Error is 0.5 nm to port (requires a course change to starboard).

During normal operation, the following icons may be displayed on the screen depending on setup:

Symbol	Meaning
A or B	Channel suffix
AIS	AIS is enabled
	Flashing if a weather alert has been received (US models only)
ATIS	ATIS is enabled
	Low battery warning. Activates at 10.5 V
	Incoming DSC call. Flashing if there are unread call log messages
CAN	Canadian channel bank is selected
CH1 , CH2 , CH3	Favourite channel 1, 2 or 3 is selected
	The current channel is a duplex channel
DSC	DSC is enabled
DW	Dual watch mode
Hi	High transmission power (25 W)
INT	International channel bank selected
Lo	Low transmission power (1 W)
LOCAL	'Local' sensitivity selected.. Otherwise blank for distance sensitivity
PRI	The priority channel is selected
RX	The radio is receiving
S	The Shift key has been pressed
SAME	The SAME alert setting is 'ON'
SCAN	Channel scanning in operation
SKIP	This channel is being skipped in the scan
TRI	Tri watch mode
TX	The radio is transmitting
USA	USA channel bank is selected
	Auto Switch is set to OFF
•	Voice recording is ON

Modes

The RS90S has several different modes of operation. The main mode is standby mode, during which the radio is ready to send or receive VHF calls. Generally, pressing the [X] key will exit any special mode and return to standby mode.

Scanning mode

In scanning mode, the radio scans selected channels for radio activity.

Navigation mode

Navigation mode displays distance and bearing to a selected waypoint.

Hailer mode

Hailer mode allows you to use the radio to hail other vessels or deck crew through a connected loud-hailer speaker.

Hailer mode also features a listen-back mode, which uses the PA speaker as a microphone to listen for a response.

Fog horn mode

Fog horn mode allows you to use the radio to sound a fog horn tone through a connected loud-hailer speaker.

Intercom mode

Intercom mode allows you to use the handsets to communicate from one handset to the others in your vessel.

Standby Mode

In standby mode, the RS90S displays the main operating screen on the handset(s) and is ready to send or receive calls on the selected channel.

Changing channel

Different jurisdictions in the world have allocated different sets of VHF radio channels for different purposes. These sets are known as channel banks. The available channel banks and their corresponding channels are given in "Appendix 7 - Channel charts" on page 119.

Normally the radio should be left tuned to the priority channel CH16 (CH16 or CH09 (US models)) in case an emergency call is broadcast on that channel. The RS90S can also be set to monitor several channels at the same time. In this case, the radio continuously scans the selected channels and, if activity is heard on a channel, it will switch to that channel while the activity continues. Then it will revert to scanning. See “Scanning channels” on page 29.

You can use one of the following methods to change channel:

- Press [16/9] to switch immediately to the priority channel (see “Priority channels” below).
- Press ▲ or ▼ until you reach the required channel number.
- Press and hold ▲ or ▼ to rapidly scroll through the channel numbers. When the number you require is displayed, release the key.
- Input the number on the keypad (wired handset only), and when the required channel number is flashing on screen, press [OK], or wait for 2 seconds for the number to be accepted automatically. When entering a single-digit channel number, prefix the channel number with 0.
- Repeat press [3CH] to scroll through your three favourite channels. See “Three favourite channels 3CH” on page 29.
- Press [WX] and then ▲ or ▼ to tune to a weather station (US model only). See “Receiving weather alerts (US model only)” on page 27.
- Press [WX] to go directly to a set favourite channel (EU models only).

Priority channels

Channel 16 is the international emergency priority channel. On Channel 16, operators must give priority to any emergency calls occurring on that frequency. In the US, Channel 9 is also an emergency priority channel.

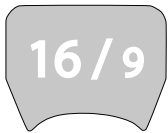

To switch directly to Channel 16 (or Channel 9 if configured):

- Press the 16/9 button.
- **Note:** The default emergency channel is CH16. On US models, you can change the default emergency channel to CH9 by holding down 16/9 until the unit beeps and displays 09. Repeat the procedure to change back to CH16 as the default emergency channel.

Adjusting squelch

The squelch adjustment allows you to adjust the sensitivity of the radio so that background noise is minimized. In areas of high static noise, such as close to large cities, you can improve quality of reception by adjusting the squelch.

- Use the ◀ and ▶ keys to adjust the level up or down respectively.
 - Adjust the level until the background noise just disappears.
- **Note:** You can also adjust the sensitivity of the VHF receiver using the Local/Distance setting. See “Radio sensitivity” on page 108.

Setting transmission power

The RS90S has two transmission power settings:

High 25 W (Hi)

Low 1 W (Lo)

To change the power setting:

Press and hold [H/L] until the Hi or Lo icon on the display changes.

→ **Notes:**

- Channel 16 always remains in high transmission power.
- Some channels allow only low-power transmissions. If you try to change to high power, the RS90S will sound an error beep.
- Some channels allow only low power transmissions initially, but can be forced to high power by holding down [H/L] and PTT at the same time.
- See “Appendix 7 - Channel charts” on page 119 for a list of channel data.

PTT Key

The Push to Talk (PTT) key activates the microphone and transmits your voice over the selected channel.

→ Notes:

- Pressing PTT while a menu is displayed will exit the menu without making any selection.
- DSC transmission has higher priority than PTT voice transmission.
- During PTT transmission, the radio cannot receive a DSC call.
- If PTT gets stuck or accidentally held in the talk position, a built-in timer sounds an error beep and shuts down the transmission after 5 minutes.

Using the menus

The [CALL/MENU] button provides access to two different menus as follows:

- Short press to access the DSC menu.
- Long press (press and hold) to access the main menu.

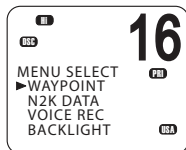
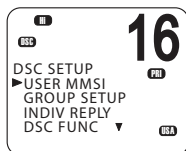

To use the menus:

- Use ▼ or ▲ to scroll to the option you want.
- Press [OK] to select a menu option, or
- Press [X] to go back without selecting an option.

→ **Note:** If the radio is left in menu mode, after a default time of 10 minutes, it beeps a warning and then automatically returns to standby mode.

Shortcut keys

The RS90S wired handset keypad includes a SHIFT key that modifies the function of some keys.

- Press [SHIFT] to display the shift icon (S), and then press the number key to access the required function.

SHIFT + 2

Press [SHIFT], then press 2 to access the AIS SETUP menu.

SHIFT + 3

Press [SHIFT], then press 3 to access the external speaker ON/OFF.

SHIFT + 4

Press [SHIFT], then press 4 to access the Waypoint menu.

Entering data

Entering data with a wired handset

Enter data using the keypad. The first press of a key inputs the number corresponding to the key; subsequent presses input letters of the alphabet as indicated on the key. For example, 2, A, B, and C are typed using the same key.

After a short pause, the cursor automatically jumps to the next space; or, you can press [OK] to move to the next space immediately.

→ **Note:** Characters can only be entered in upper case.

To replace a character:

- Use the ◀ and ▶ keys to move the cursor to the character. You can then type over the character.

To finish entering data:

Press [OK] repeatedly to reach the end of the line. The cursor will then move to the next input required, or a save/cancel option will be displayed for you to select as required.

→ **Note:** You can press [X] at any time to go back one step.

Entering data with a wireless handset

Use the ▲ and ▼ keys to scroll through the available characters, and then press [OK] to select the required character.

Warning messages

See "Appendix 4 - Warning Messages" on page 113.

Alert tones

See "Appendix 3 - Beep tones and call alerts" on page 113.

3

Operating procedures

Making a routine radio call

Making a routine ship to ship or ship to shore call.

1. Select a calling channel.
See “Changing channel” on page 20.
 2. Listen to make sure that there is no traffic on the channel.
 3. Hold down [PTT] and announce the station you want to contact and your own vessel’s details. When you have finished speaking, say “Over” and then release [PTT].
 4. When you receive a reply on the calling channel, agree a working channel.
 5. Change to the working channel.
 6. Continue the conversation:
 - Hold down [PTT] while you are speaking.
 - Release [PTT] while you are listening.
 7. When finished, press [16/9] to return to the radio watch channel.
- **Note:** When you call a coast station, the coast station operator normally states a suitable working channel.

Calling a buddy

You can call a buddy using their MMSI on the DSC system. For further information, see “Introduction to DSC” on page 40.

Making a channel 16/9 distress call

1. If not already on the priority channel, press the [16/9] key.

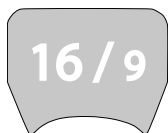

2. Listen to make sure there is no traffic on the channel.
3. Hold down [PTT] and announce your distress call.
4. Say your call sign, details of your vessel, its position and the nature of the distress.
5. Say “over” and then release [PTT] when you have finished speaking.
6. Allow a short time for a reply.
7. If you don’t hear a reply, repeat the distress call (steps 3 to 6 as above).
8. When you receive a reply, continue the conversation:
 - Hold down [PTT] while you are speaking.
 - Release [PTT] while you are listening.

You may be asked to change to a working channel.

→ **Notes:**

- In the USA, you can toggle between Channel 16 and Channel 9 as the priority channel. Hold down [16/9] until a beep sounds and the required priority channel is displayed.
- This feature needs to be setup in the radio settings (“Setting the priority channel” on page 90).

Making a DSC distress call

Using the DSC system (where available) you can make a distress call by pressing a single Distress button. For further information, see “Introduction to DSC” on page 40.

Receiving weather alerts (US model only)

The National Oceanic and Atmospheric Administration (NOAA) provides several weather forecast channels on USA and Canadian channel banks. If severe weather is forecast, the NOAA broadcasts a weather alert on 1050 Hz.

To access weather alerts:

1. Short press [WX] to enter WX mode.
 2. Press ▲ or ▼ to change WX channel.
 3. If WX TONE ALERT setting is ON (see “Setting up weather tone alert” on page 91), the radio will monitor the WX channel you select. If an alert tone is broadcast from the NOAA weather station, the weather alert is picked up automatically and the RS90S alarm sounds. Press any key to cancel the alarm and to hear the weather alert message.
 4. When finished, press [WX] again or [X] to exit WX mode.
- **Note:** In WX mode, the Wx icon appears on screen.

Receiving SAME alerts (US model only)

The NOAA All Hazards Weather Radio Service (NWR) works in conjunction with the Emergency Alert System (EAS) to issue weather alerts for specific geographic areas or weather warnings. It uses a digital encoding system known as Specific Area Message Encoding (SAME) to broadcast these alerts.

Each transmitter in the NWR network is identified with a unique 6-digit SAME code.

If SAME is enabled and the 6-digit country IDs you want to monitor have been entered, the radio will sound the weather alarm when it detects a weather alert on the selected weather channel.

For SAME alert setup, see “Setting up SAME alert” on page 92.

Receiving a SAME ALERT

If SAME ALERT is ON and an NWR or EAS alert for your geographic area is broadcast, the RS90S detects the alert signal and sounds the alarm.

Press any key to cancel the alarm.

- If the alert is being sent by NOAA NWR, the radio automatically tunes to the designated frequency so that you can listen to the alert.
- If the alert is being sent by the EAS, the nature of the alert is shown on screen as WARNING, WATCH, ADVISORY, or TEST.

Press any key to show the nature of the alert.

- **Note:** The list of alerts is shown in “Appendix 3 - Beep tones and call alerts” on page 113.

Receiving SAME TEST messages

In addition to the WARNING, WATCH and ADVISORY alerts, the EAS also send out TEST messages so that you can check that your WX ALERT setup is working correctly. The TEST message is usually transmitted between 1000 and 1200 (10.00AM and noon) every Wednesday.

If your WX ALERT setup is working correctly, the alert sounds and TEST is displayed on screen, followed by a broadcast message from the National Weather Service.

- **Note:** If there is a threat of severe weather, the test will be postponed until the next fine weather day.

Favourite channel (non-US models)

In standby mode, press [WX] to access your favourite channel, press again or [X] to go back to the last working channel.

- **Notes:**

- To set up the favourite channel, see “Setting up a favourite channel” on page 91.
- You can store just one channel as the favourite channel. It can, for example, be a weather reporting station.

Three favourite channels 3CH

Once set up, you can use the three favourite channels in two ways:

- Repeat press [3CH] to toggle between your three favourite channels, or
- Scan the three channels and the priority channel.

To add a favourite channel:

- To add a favourite channel for the first time, select that channel then hold 3CH to store it in the CH1 location.
- You can repeat the procedure to store two more favourite channels in the CH2 and CH3 locations respectively.
- Once the three locations are full, if you try to add another favourite channel, the radio will overwrite the CH3 location after prompting you to confirm.

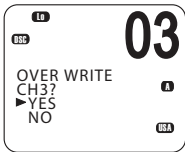

To delete a favourite channel:

- Select that channel and then hold down [3CH]. The radio will remove that favourite channel after prompting you to confirm.

To toggle between your three favourite channels:

- Press [3CH] to enter 3CH mode.
- The radio displays "3CH MODE" and CH1, CH2, or CH3 to show which of your favourite channels is currently selected.
- Repeat press [3CH] to switch between the three channels.

To exit 3CH mode:

- Press [X].

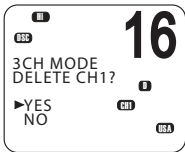

Scanning channels

The RS90S can automatically monitor more than one channel at the same time. It scans a selected range of channels, and when a valid signal is received, the radio stops scanning and remains on that channel so that you can hear the communication. However, if the signal from the channel ceases for more than 5 seconds, the scan automatically restarts.

Four scan modes are provided:

- **All scan**
Scans all available channels in sequence, but also checks the priority channel every 2 seconds.

- **Dual watch scan**
Scans the selected channel and channel 16.
- **3CH scan**
Scans your three favourite channels and the priority channel.
- **Tri watch scan** (US models only)
Scans the current channel, channel 16 and channel 9.

ALL SCAN mode

Hold down [SCAN] for about 3 seconds to start ALL SCAN mode. The radio displays the SCAN icon and "ALL SCAN." You will see the channel numbers changing.

- If you hear a communication of interest, press [SCAN] or [PTT] to stop at the currently scanned channel.
- Press [X] to quit scan mode and return to the previously selected channel.

→ **Notes:**

- Scan is not allowed in some EU countries.
- If TONE ALERT or SAME is enabled (US models only), the weather channel is also scanned.

Skipping busy channels

If one channel is always busy with traffic, you can set the radio to skip that channel during scanning.

To skip a channel:

- While the channel is displayed during scan, press [OK] to skip over it.

To resume scanning a skipped channel:

- With scanning OFF, as you scroll up and down through channels, the SKIP icon will be displayed when you are on a skipped channel. With the SKIP channel selected, press [OK] to cancel the SKIP function.

→ **Notes:**

- You cannot skip the priority channel.
- The SKIP icon will disappear when the radio is powered OFF/ON.

3CH scan mode

- With any of your favourite channels selected (by pressing the 3CH key), hold down [SCAN] to start scanning your favourite channels and the priority channel.
- Press [SCAN] again to stop at the broadcast channel.
- During scanning, press [X] to cancel 3CH scanning and return to the previously selected channel.
- Press SCAN or PTT to stop at the currently scanned channel.
- To scan only one of your favourite channels, press 3CH then immediately press and release SCAN.

For further information on 3CH, see “Making a routine radio call” on page 25.

- **Note:** 3CH scan functionality is limited in some European countries and, if ATIS is enabled, the 3CH scan mode will be disabled.

Dual watch scan

Dual watch scan monitors the current working channel and the priority channel.

To enter dual watch scan:

- Short press [SCAN].
The DW icon will be displayed on screen.

To exit dual watch scan:

- Press [SCAN] or [X].

→ **Notes:**

- For US models, you can select Channel 9 as the priority channel (see “Priority channels” on page 21).
- To scan both channel 16 and channel 9, see “Tri watch scan” next page.

Tri watch scan

(US models only)

Tri watch monitors the current working channel, Channel 16 and Channel 9.

For tri watch, you need to enable both channel 16 and channel 9 as priority channels. See “Setting the priority channel” on page 90.

To enter tri watch scan:

- Short press [SCAN].
The TRI icon will be displayed on screen.

To exit tri watch scan:

- Press [SCAN] or [X].

Using the hailer

If the RS90S is connected to a suitable public address (PA) speaker, you can use the Hailer function to hail other vessels or deck crew. The Hailer function also features a listen-back mode, which uses the PA speaker as a microphone to listen for a response.

1. Press and hold [AIS/IC] until the HAILER menu appears.
2. Select HAILER.
3. Press [PTT] to talk.
4. Release [PTT] to listen for a response.
5. When finished, press [X] to exit Hailer mode.

→ Notes:

- While pressing [PTT], you can change the volume of the PA speaker using the volume control on the side of the handset.
- Hailer mode is only available on the wired handsets.

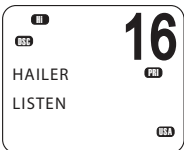
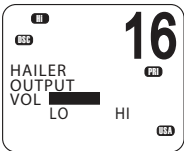

Using the fog horn

If the RS90S is connected to a suitable public address (PA) speaker, you can use the Fog Horn function to sound certain international standard fog horn tones through the PA speaker.



1. Press and hold [AIS/IC] until the HAILER menu appears.
2. Select FOG HORN.

There are 8 internationally recognized fog horn signals available:

HORN	Manual operation
UNDERWAY	One long tone
STOP	Two long tone
SAIL	One long, two short
ANCHOR	One long warble
TOW	One long, three short
AGROUND	Warble sequence
SIREN	Manual operation

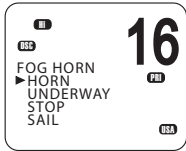

3. Select the required signal, then press [OK] to start.
 - Press [OK] to sound the HORN or SIREN.
 - The other signals will sound automatically approximately every two minutes until you press [X] to cancel.
4. When finished, press [X] to exit horn mode.

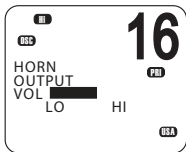

→ Notes:

- When the fog horn is not sounding, it is in Listen mode.
- While pressing [PTT], you can change the volume of the PA system using the volume control on the side of the handset.
- In Horn mode, you can press [PTT] to talk through the PA speaker.
- If a horn button has been installed, you can press the button for a momentary sounding of the horn.



Using the intercom

When two or more handsets (wired or wireless) are installed, you can use the radio to communicate between handsets.



1. Press and hold [AIS/IC].
2. Select INTERCOM from the menu.
3. Press [PTT] to talk.
4. When finished, press [X] to quit Intercom mode.

→ Notes:

- Intercom mode only works when two or more handsets are installed. While the intercom is being used, the VHF radio is disabled, except for incoming DSC calls.
- The intercom system is half duplex; you cannot receive and transmit at the same time; you must release the [PTT] key to listen.
- The receiving handset(s) can adjust their volume controls.



Using the announce function

You can use the handset to make announcements to the other handsets and any external speakers that are connected.



1. Press and hold [AIS/IC] until the HAILER menu appears.
2. Select ANNOUNCE.
3. Press [PTT] to talk.
4. When finished, press [X] to exit Announce mode.

→ Notes:

- The Announce function does not listen for a response.
- During Announce mode, if a voice signal is received on a VHF channel, an Rx icon appears on screen.
- If an alert such as ATIS, AIS, DSC or WX is received, or the [DISTRESS] key is pressed or a DSC call received, the radio will exit Announce mode and handle the alert or DSC call.



Using the voice recorder

When activated, the voice recorder function records all received and transmitted voice communications.

If memory is full, it will overwrite previous recordings.

Recording

Long press the voice recorder key to access the recording menu. Select RECORDER and then ON to enable the recording function.

→ **Note:** Voice recording is ON by default.

Playback

Press the voice recorder key to play the recording. A playback icon will be displayed on lower right of the screen. During playback, select 'FWD 5S' from the menu to fast forward 5 seconds.

When finished playing back, the radio will return to standby mode.

Sharing NMEA 2000 data

NMEA 2000 (N2K) is a communications network standard used for connecting marine electronic devices. It is the successor to NMEA 0183.

→ **Note:** The RS90S also supports NMEA 0183.

Various devices can be connected via a network cable and can share data on the network. This allows the devices to work together and, for example, one display unit can show information from different sources.

The RS90S uses N2K to share the following data:

- Waypoint data to a chart plotter. See "Sending waypoint data to a chart plotter" on page 39.
- AIS
- Display navigation data received from other devices: Depth, speed, course, heading and wind data.

4

Waypoint procedures

A waypoint refers to the latitude, longitude and name of a place that you have entered into the radio. A waypoint can be a destination, a point along a planned course, or any location useful for navigation, such as a fishing spot.

You can use waypoints as follows:

- Display the coordinates, bearing and distance to a waypoint on the standby screen. See “Navigating to a waypoint” on page 38.
- Output a waypoint’s coordinates and other details via NMEA 2000 for display on a chart plotter or other compatible device. See “Sending waypoint data to a chart plotter” on page 39.

→ **Note:** The RS90S can store up to 200 waypoints.

Adding a new waypoint

1. Select MENU → WAYPOINT → WP LIST.

Your waypoint list will be displayed.

2. Press [OK].

NEW WP starts to flash.

3. Press [OK] again to add a new waypoint.
4. Enter a waypoint name (maximum 6 characters).
5. Enter the latitude. Use ▲ or ▼ key to select N or S as required, and then press [OK] to move to the longitude setting.
6. Enter the longitude. Press [OK] once you have selected E or W.
7. When prompted, select YES or NO to save the new waypoint.

→ **Note:** When the waypoint list is full, you must delete an entry before you can create a new entry.

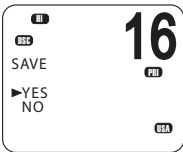
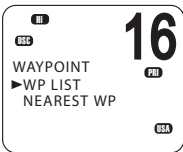
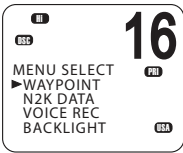

Editing a waypoint

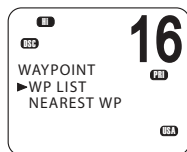

1. Select MENU → WAYPOINT → WP LIST.
The display shows your list of waypoints.



2. Press [OK].
NEW WP starts to flash.
3. Scroll down to the entry you want to edit.
4. While the required waypoint is flashing, press [OK].
5. To edit the waypoint, select WP EDIT.

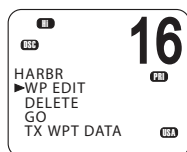

6. Edit the waypoint name, latitude or longitude. You can press [OK] repeatedly until the cursor moves to the required place.
7. When finished, press [OK] repeatedly if necessary to reach the SAVE prompt.
8. Select YES or NO to save the data as required.

Deleting a waypoint

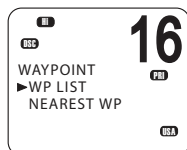

1. Select MENU → WAYPOINT → WP LIST.
The display shows your list of waypoints.



2. Press [OK].
NEW WP starts to flash.
3. Scroll down to the entry you want to delete.
4. While the required waypoint is flashing, press [OK].
5. Select DELETE.

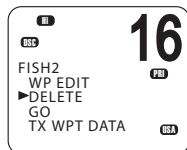

6. If you select YES at the prompt, the waypoint will be deleted immediately.

Navigating to a waypoint

Navigating to a waypoint requires two steps:

- Selecting which waypoint you want to navigate to.
- Pressing [NAV] to go to Navigation mode.

These steps are explained below.

Selecting a waypoint from your list

1. Select MENU → WAYPOINT → WP LIST.
2. Press [OK] and then scroll to the required waypoint and press [OK] again.
3. Select GO.
4. When prompted, select YES.

When in Navigation mode (see below), the distance and bearing from your current position to the selected waypoint will be displayed on the bottom line of the standby screen.

Selecting the nearest waypoint

→ **Note:** This option is only available when a valid signal from a GPS device is present.

1. Select MENU → WAYPOINT → NEAREST WP.

The display shows your list of waypoints with the nearest at the top.

2. Scroll to the required waypoint and press [OK].

When in Navigation mode, the distance and bearing to it from your current position will be shown on the bottom line of the standby screen.

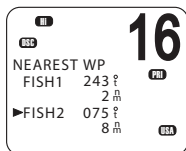
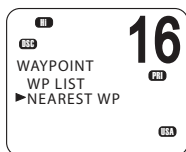
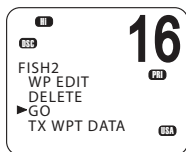
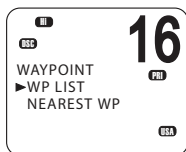

Entering navigation mode

- Long press [NAV] to enter navigation mode.

In navigation mode, the following details about the destination waypoint will be displayed on the standby screen:

Name of waypoint

B: Bearing in degrees; 't' for true

D: Distance

X: Cross track error

Cross track error is the distance the vessel is to one side of the straight line between two waypoints.

Exiting navigation mode

- Long press [NAV] or press [X].

Stop navigating to a waypoint

1. Select MENU → WAYPOINT → WP LIST.
2. Press [OK] then scroll to the required waypoint and press [OK] again.
3. Select WP STOP.
4. When prompted, select YES.

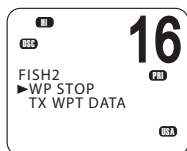

Sending waypoint data to a chart plotter

You can send waypoint data via NMEA 2000 to a compatible chart plotter.

1. Select MENU → WAYPOINT → WP LIST.
The display shows your list of waypoints.
2. Press [OK].
3. Scroll to the required waypoint, and then press [OK].
4. Select TX WPT DATA to send the data to the chart plotter.

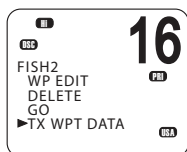

5

DSC procedures

Introduction to DSC

DSC (Digital Selective Calling) is part of the Global Maritime Distress and Safety System. It allows radio stations to contact each other on a dedicated digital channel (channel 70). The radios automatically exchange the digital contact and acknowledgement messages on channel 70, freeing up the other VHF channels for voice communications.

Once they have established contact, both radios automatically switch to a VHF working channel for the operators to carry out normal voice communication.

Each DSC radio has a unique 9-digit number, known as a Maritime Mobile Service Identity (MMSI), which is used to contact that individual radio.

DSC radios continuously monitor channel 70 irrespective of what other channels they are working on. If someone calls your vessel via DSC, your radio will sound an alert tone for you to respond to the call.

If the RS90S radio is connected to a GPS system, it will automatically send your location when calling other stations. This is especially useful for distress calls.

DSC process

The calling and acknowledging process on channel 70 operates as follows:

1. The calling radio transmits a DSC signal on channel 70.
2. Receiving radio(s) sound alert tones for their operators.
3. For individual, LL request and DSC test calls, the receiving radio sends a DSC acknowledge signal on channel 70.
4. Both the calling and receiving radios switch to a working VHF channel (except for LL request and DSC test calls).
5. Calling and receiving operators commence normal VHF voice communications on the working channel.
6. Press [X] to return to standby mode.

DSC Distress calls

Initiating an UNDEFINED distress call immediately

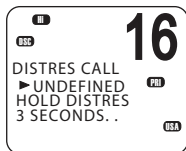

1. Flip open the red cover on top of the handset.
2. Press and hold the red [DISTRESS] key for about 3 seconds.

The radio counts down the 3 seconds, and then:

- Beeps loudly,
- Displays “DISTRESS CALL SENDING” on screen, and
- Sends out the UNDEFINED distress call to all stations on channel 70.

3. Release the [DISTRESS] key.
4. If you have time, observe any acknowledgement of your call and follow up by sending a MAYDAY distress call on Channel 16. See “Continuing a distress call” on page 43.

Initiating a distress call of specific nature

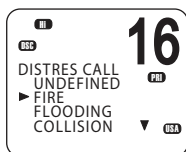

1. Flip open the red cover on top of the handset.
2. Press the red [DISTRESS] key briefly.
3. The radio will display a list for you to select the nature of the distress:

UNDEFINED
FIRE
FLOODING
COLLISION
GROUNDING
LISTING
SINKING
ADRIFT
ABANDONING
PIRACY
OVER BOARD

4. USE the ▲ and ▼ keys to reach the required nature of distress, and then press and hold the [DISTRESS] key for about 3 seconds.

The radio counts down the 3 seconds, and then:

- Beeps loudly,
- Displays “DISTRESS CALL SENDING” on screen, and
- Sends out the specified distress call to all stations on channel 70.

5. Release the [DISTRESS] key.

Continuing a distress call

1. After you have initiated a distress call as above, the radio goes into call repeat mode—it automatically repeats the distress call approximately every 4 minutes, until the call is acknowledged by an official search and rescue station.

The display shows the time remaining to the next resend.

You can press ▼ or ▲ to scroll through the transmitted Distress call information.

2. You now have the following soft-key options:

- **RESEND**

Displays “HOLD DISTRESS 3 SECONDS TO SEND.” You can then:

- Hold down the red [DISTRESS] key for 3 seconds to resend the call, or
- Press the [EXIT] softkey to return to waiting for an acknowledgement.

- **PAUSE**

Pauses the call repeat mode. You can then:

- Press the [EXIT] softkey to resume the same call.

- **CANCEL**

Displays “DISTRESS CALL SEND CANCEL.” You can then:

- Press the [NO] softkey to return to waiting for an acknowledgement.
- Press the [YES] softkey to send the DISTRESS CANCEL signal.
- Press [PTT] and report your situation using the handset.
- When finished talking, press [X] to return to standby mode.

3. After receiving an acknowledgment, press the [SILENC] softkey.

4. Press [X] to quit the current distress acknowledgment.

→ **Notes:**

- Prior to receiving an acknowledgement, you cannot terminate the distress alert call. It can only be cancelled by completing the distress call cancel process as described above.
- Call information is stored in the Distress Call Log. See “Calling using the distress log” on page 51.

Receiving a distress call

When the radio receives a DSC distress call, it:

- Sounds a two-tone alarm through the handset(s) and speaker(s), and
- Automatically switches to channel 16 after 10 seconds if there is no user intervention.

If the two-tone distress alarm sounds on your radio:

1. Press the [SILENC] softkey to silence the alert.

You do not need to send a DSC acknowledgement; this will be done by an official search and rescue station.

2. Maintain a listening watch on Channel 16 for voice communications from ship and coast stations about the distress.
3. You can then:
 - Press ▼ or ▲ to scroll through details of the distress call,
 - Press [PTT] to talk, or
 - Press [X] to exit the DSC session.

Distress acknowledgement: (DISTRESS ACK)
or distress relay all ships: (DISTRESS REL)

Only official Search and Rescue stations are permitted to send these signals.

When your radio receives a Distress Acknowledgement signal it does the following:

- Cancels any Distress Mode transmissions,
 - Sounds a two-tone alert, and
 - Automatically switches to channel 16 after 10 seconds if there is no user intervention.
1. Press the [SILENC] softkey to silence the alert.
 2. Press the [ACCEPT] softkey to switch to CH16 immediately.
 3. Maintain a listening watch on CH16, and standby to give assistance.
 4. You can:
 - Press ▼ or ▲ to scroll through details of the call,
 - Press PTT to talk to the coast station or other ship, or
 - Press [X] to exit the DSC session.

Distress relay individual (INDIV DISTR RELAY)

When the radio receives an Individual Distress Relay call, it sounds the alert tone and displays INDIV DISTR RELAY.

1. Press the [SILENC] softkey to silence the alarm.
2. You can then:
 - Press ▼ or ▲ to scroll through details of the call.
 - All models
Press the [ACCEPT] softkey to immediately accept the change to CH16. Note: The radio automatically changes to CH16 after 10 seconds.
 - US models
Press [ACK] softkey to ACK the call.
 - Press [X] to quit the current DSC session.

Sending routine DSC calls

Briefly press [CALL / MENU] to access the DSC menu options:

Call type	Page
INDIVIDUAL	page 46
LAST CALL	page 47
GROUP	page 48
ALL SHIPS	page 49
CALL LOG	page 50
DISTR LOG	page 51
SENT CALL	page 52
LL REQUEST	page 52
TRACK BUDDY	page 53
DSC TEST	page 56

The above functions are explained in the sections below.

To make a DSC Distress call, see “DSC Distress calls” on page 42.

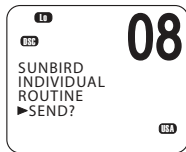
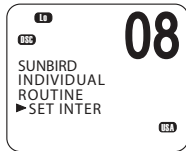
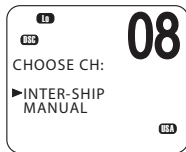
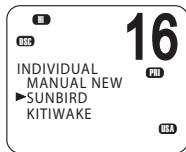
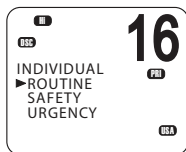
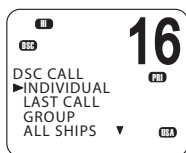
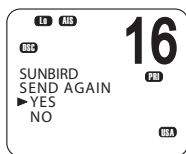
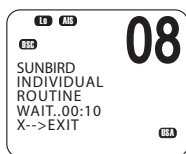

General usage

- When an alert sounds, press the [SILENC] softkey to stop the beeping sound.
- When choosing a working channel, select INTER-SHIP; the radio will automatically list suitable ship-to-ship (Simplex) channels that you can use for a particular function. Duplex channels cannot usually be called, however, if you wish to use a Duplex channel, select MANUAL, and then select your channel of choice. If the call is to a Coast Station the radio will recognize this and specify the correct working channel.
- After sending an LL request, the radio waits for 30 seconds for an acknowledgement before prompting you to send again.

Sending an individual DSC Call

1. Select DSC MENU → INDIVIDUAL.
2. Select the priority level: ROUTINE, SAFETY or URGENCY.
3. Select the buddy you want to call from the list, or
 - Select MANUAL NEW and enter the MMSI you want to call.
4. On the “CHOOSE CH” screen, select INTER-SHIP. (Or, select MANUAL to use a duplex channel—see point 2 of “General usage” on page 46.)

The display shows “SET INTER”

5. Use ▲ or ▼ to reach the working channel you want to specify and press [OK].
6. When the SEND prompt appears:
 - Press [OK] to send the call request on CH70, or
 - Press [X] to exit without sending.
7. When you hear the acknowledgement alert tone:
 - Press the [SILENC] softkey to silence the alert.
 - Press [PTT] to commence voice communication.
8. If there is no reply within 30 seconds, the display shows: “SEND AGAIN?”

You can then select:

- [YES] to send again, or
- [NO] to quit and return to standby mode.

→ **Note:** For information on receiving an individual DSC call, see “Receiving a DSC individual call” on page 59.

Calling the MMSI of the last call received

(This will send a ROUTINE, INDIVIDUAL call.)

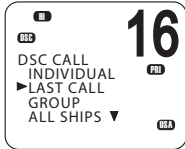

1. Select DSC MENU → LAST CALL.
2. The display shows the details of the most recent incoming call.
3. Press [OK] to display the “CHOOSE CH” screen.
4. On the “CHOOSE CH” screen, select INTER-SHIP. (Or, select MANUAL to use a duplex channel—see point 2 of “General usage” on page 46.)

The display shows “SET INTER”

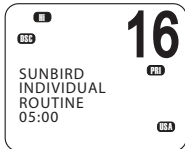

5. Use ▲ or ▼ to reach the working channel you want to specify and press [OK].

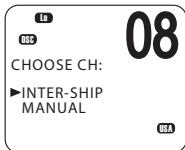

6. When the SEND prompt appears:
 - Press [OK] to send the call request on CH70, or
 - Press [X] to exit without sending.

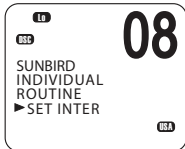

7. When you hear the acknowledgement alert tone:
 - Press the [SILENC] softkey to silence the alert.
 - Press [PTT] to commence voice communication.

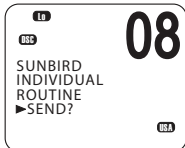

8. If there is no reply within 30 seconds, the display shows: “SEND AGAIN?”

You can then select:

- [YES] to send again, or
- [NO] to quit and return to standby mode.

Sending a group call

A group MMSI is a shared MMSI. When a DSC call is transmitted by one of the vessels in the group, all the radios that have the same MMSI entered will receive the message, and can reply on the chosen channel if necessary.

To enter a group MMSI, see “Creating a group MMSI” on page 96.

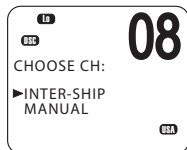
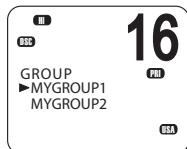
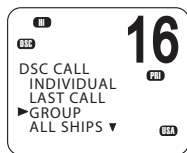

→ Notes:

- Unlike the DSC or ATIS MMSI, a group MMSI can be changed at any time.
- Group calls are always sent with ROUTINE priority.
- No DSC acknowledgement is required for a group call.

1. Select DSC MENU → GROUP.
2. The display shows the names of your pre-programmed groups.
3. Select the group that you want to call.
4. On the “CHOOSE CH” screen, select INTER-SHIP. (Or, select MANUAL to use a duplex channel—see point 2 of “General usage” on page 46.)

The display shows “SET INTER”

5. Use ▲ or ▼ to reach the working channel you want to specify and press [OK].
6. When the SEND prompt appears:
 - Press [OK] to send the call request on CH70, or
 - Press [X] to exit without sending.

→ **Note:** For information on receiving a group call, see “Receiving a DSC group call” on page 60.

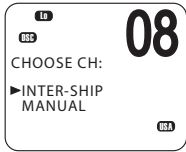
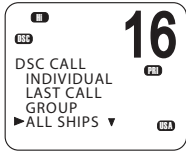

Sending an all ships call

1. Select DSC MENU → ALL SHIPS.
 2. Select one of the two call priorities:
 - SAFETY
Use to send safety information to all ships within range.
 - URGENCY
Use when a serious situation or problem arises that could lead to a distress situation.
 3. On the “CHOOSE CH” screen, select INTER-SHIP. (Or, select MANUAL to use a duplex channel—see point 2 of “General usage” on page 46.)
The display shows “SET INTER”
 4. Use ▲ or ▼ to reach the working channel you want to specify and press [OK].
 5. When the SEND prompt appears:
 - Press [OK] to send the call request on CH70, or
 - Press [X] to exit without sending.
- **Note:** For information on receiving an all-ships call, see “Receiving a DSC all-ships call” on page 59.

Call Logs

The call logs store details of the DSC calls as follows:

Call type	Description
Last call	Details of the last incoming call
Call Log	Details of the last 20 incoming calls (does not include distress calls)
Distress log	Details of the last 20 distress calls received
Sent calls log	Details of the last 20 sent calls

You can use the call logs to call back a vessel that sent a call.

Calling using the call log

The call log contains the contact details for the 20 most recent incoming calls, so that you can call one of them back quickly.

1. Select DSC MENU → CALL LOG.

The display shows the details of the most recent call.

2. Use ▲ and ▼ to find the caller you want to call back and press [OK].

3. Choose the option:

- CALL BACK — to send a DSC call request, or
- DELETE — to delete the call from the call log.

4. On the “CHOOSE CH” screen, select INTER-SHIP. (Or, select MANUAL to use a duplex channel—see point 2 of “General usage” on page 46.)

The display shows “SET INTER”.

5. Use ▲ or ▼ to reach the working channel you want to specify and press [OK].

6. When the SEND prompt appears:

- Press [OK] to send the call request on CH70, or
- Press [X] to exit without sending.

7. When you hear the acknowledgement alert tone:

- Press the [SILENC] softkey to silence the alert.
- Press [PTT] to commence voice communication.

8. If there is no reply within 30 seconds, the display shows: “SEND AGAIN?”

You can then select:

- [YES] to send again, or
- [NO] to quit and return to standby mode.

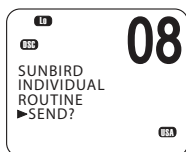
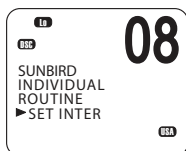
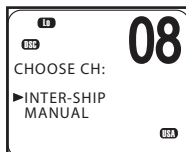
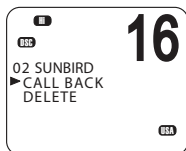
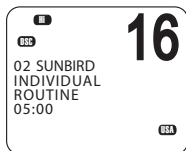
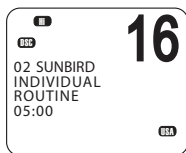

Calling using the distress log

The Distress Log contains the Distress Log data for the 20 most recently received distress calls, so that you can call any of them quickly. Always try to make voice contact on CH16 first, as follows:

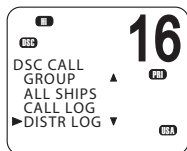

1. Select DSC MENU → DIST LOG.

The display shows the details of the most recent call.

2. Use ▲ and ▼ to find the caller you want to call back and press [OK].
3. Choose CALL BACK — to send a call request.

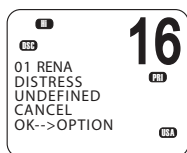

Other options are:

- DELETE — to delete the call from the distress log.
- SAVE MMSI — to save the caller's MMSI.
- INFO — to view more information about the distress call.

4. On the "CHOOSE CH" screen, select INTER-SHIP. (Or, select MANUAL to use a duplex channel—see point 2 of "General usage" on page 46.)

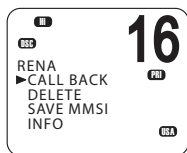

The display shows "SET INTER"

5. Use ▲ or ▼ to reach the working channel you want to specify and press [OK].
6. When the SEND prompt appears:
 - Press [OK] to send the call request on CH70, or
 - Press [X] to exit without sending.

7. When you hear the acknowledgement alert tone:
 - Press the [SILENC] softkey to silence the alert.
 - Press [PTT] to commence voice communication.

8. If there is no reply within 30 seconds, the display shows: "SEND AGAIN?"

You can then select:

- [YES] to send again, or
- [NO] to quit and return to standby mode.

Viewing the sent call log

The Sent Call log contains details for the 20 most recent calls sent from your radio.

You can review details of each call, and delete calls from the list as required.

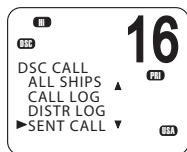

1. Select DSC MENU → SENT CALL.

The first entry in the call log is the most recent sent call.

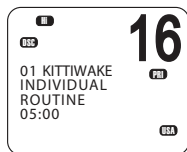

2. Press ▲ or ▼ to scroll through the sent calls.
3. With a particular call displayed, press [OK] to display the DELETE prompt:
 - Press DELETE to delete the entry from the sent call log, or
 - Press [X] to exit without deleting.

Sending an LL request for the position of a buddy

The latitude and longitude request (LL request) function allows you to send a DSC request to an MMSI on your buddy list and the response will contain the current latitude and longitude position of the other vessel. In this way, you can check the location of your buddy. This is also known as a “polled position request.”

→ **Note:** You must first set up details of your buddy in the buddy list (see “Buddy list setup” on page 86).

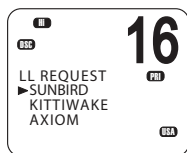
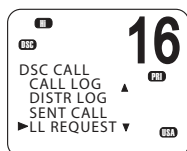

1. Press DSC MENU → LL REQUEST.
2. Select the buddy whose LL position you want to request.
3. When the “SEND?” prompt appears, press [OK] to send the LL request.
4. If the buddy radio responds with a position, the RS90S beeps:
 - Press the [SILENC] softkey to silence the alert.
 - Press ▲ or ▼ to view the LL information received.
5. If there is no reply within 30 seconds, the display shows: “SEND AGAIN?”

You can then select:

- [YES] to send again, or
- [NO] to quit and return to standby mode.

Tracking a buddy - introduction

You can select a buddy or list of buddies continuously track their positions.

You can also start and stop tracking your buddy and add or remove buddies from your buddy track list.

The radio sends an LL Request to each buddy in turn at a set time interval and, if a response is received from a buddy, it displays the buddy's LL position on screen.

To set up buddy tracking, you need to:

1. Setup your buddies list. See "Buddy list setup" on page 86.
2. Create a tracking list of up to three buddies.
3. Set the tracking interval.
4. Select a buddy to track.
5. Start/stop tracking the buddy.

Steps 2 to 5 are explained below.

- **Note:** You can also send an individual DSC latitude and longitude request to a buddy. See "Sending an LL request for the position of a buddy" on page 52.

Creating your tracking list

1. Select DSC MENU → TRACK BUDDY.
2. Select TRACKLIST. Any buddies already on the tracking list will be listed.
3. To add a buddy to the tracking list, select ADD NEW to show your list of buddies.
4. Select a buddy then press [OK] to add that buddy to the tracking list.

To delete a buddy from the tracking list

Select that buddy, then press [OK].

- Select YES to delete, or
- NO to keep the buddy in the list.

- **Note:** The tracking list is limited to three buddies.

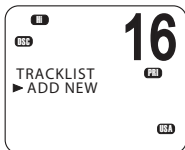
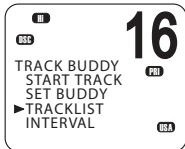
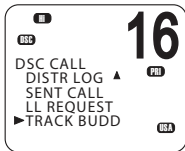

Setting the track buddy update interval

You can set the interval at which the position requests are sent out.

1. Select DSC MENU → TRACK BUDDY.
2. Select INTERVAL.
3. Select the required interval: 15, 30 or 60 minutes.
4. Press [OK].

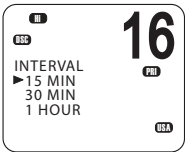
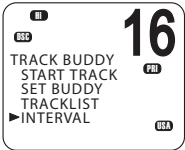
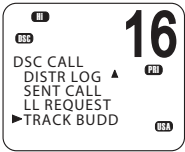

Selecting a buddy to track

1. Select DSC MENU → TRACK BUDDY.
2. Select SET BUDDY to show the tracking status of each buddy on your tracking list.
3. Select the buddy whose status you want to change.
4. Select ON or OFF as required to change the tracking status and press [OK] to confirm.

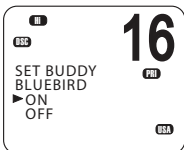
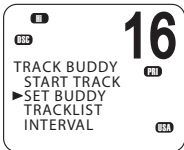
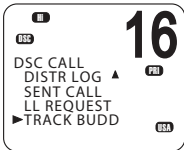

Start or stop tracking a Buddy

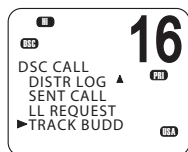

→ **Note:** START TRACK will only track buddies on your TRACKLIST whose status is ON.

1. Select DSC MENU → TRACK BUDDY.
2. Select START TRACK.

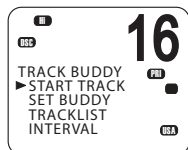

The display shows the status of each buddy on your tracking list (ON or OFF).

3. Check that the status of the buddies that you want to track is ON, and then press [OK].



4. When prompted:
 - Select YES to start tracking, or
 - NO to STOP tracking.

The radio sends an LL Request to each buddy in turn at the interval time and, if a response is received from a buddy, displays the buddy's LL position on screen.

For information on receiving a response to an LL request, see "Receiving a response to a DSC LL request" on page 61.

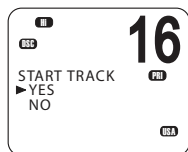

Sending a DSC test call

To make sure DSC is working correctly, you can send a test call to a buddy or any other station equipped with a DSC radio.

1. Select DSC MENU → DSC TEST.
2. Select a buddy from your buddy list, or select MANUAL NEW to enter the MMSI you want to call.
3. When the SEND prompt appears:
 - Press [OK] to send the request on CH70, or
 - Press [X] to exit without sending.
4. When you hear the acknowledgement alert tone:
 - Press the [SILENC] softkey to silence the alert.

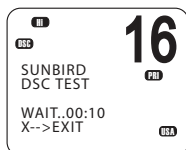
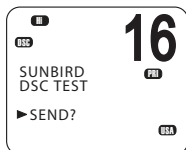
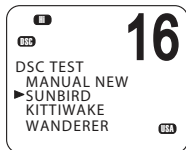
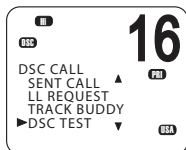

5. If there is no reply within 30 seconds, the display shows: “SEND AGAIN?”

You can then select:

- [YES] to send again, or
- [NO] to quit and return to standby mode.

→ **Note:** For information on receiving a DSC test call, see “Receiving a DSC test call” on page 61.

Receiving DSC calls

Several types of DSC calls can be received from vessels or coast stations within range:

Call type	Page
Distress	page 58
Individual	page 59
All ships	page 59
Group	page 60
Geographic	page 60
DSC test call	page 61

General process

When the radio receives a DSC call, it does several things as follows:

- Sounds the alert tone to notify you of the call.
- Displays a flashing  icon on screen, which indicates that a call has been received and stored in the call log. When all call in the call log and distress log have been viewed, the icon stops flashing. For information on call logs, see “Calling using the call log” on page 50.
- Displays the MMSI (or name) of the calling station. You can press ▲ and ▼ to view more details of the call, including the requested working channel.
- For individual calls, displays “AUTO SWITCH” or “NO AUTO SW,” depending on the INDIV REPLY setting. It will automatically or manually send an acknowledgement to the calling radio and switch to the requested channel.
- For Group or All-Ships calls, displays “AUTO SWITCH” or “NO AUTO SW,” depending on the Auto Switch setting.

With Auto Switch set to ON, when receiving a Group or All-Ships call, the radio will automatically switch to the requested channel if not cancelled within 10 seconds. This might disrupt important communications that are already in progress on the current working channel. To avoid this, you can prevent the radio from automatically switching channel by setting the AUTO SWITCH option to OFF.

For information on setting the auto switch option, see “Automatic channel switch options” on page 99.

The procedures for receiving calls with Auto Switch either on or off are described below.

AUTO SWITCH

(For Group or All-ships calls with AUTO SWITCH set to ON)

When the radio sounds the incoming DSC call alert:

1. Press the [SILENC] softkey to silence the alert.
2. To see more details about the call, including the requested channel, press ▲ or ▼.
3. You now have the following three options:
 - Press [ACCEPT] to switch to the requested channel immediately, or



- Do nothing to allow the radio to automatically switch after 10 seconds, or
 - Press [X] to cancel the automatic switch and remain on the current channel.
4. When needed, press [PTT] to talk on the selected working channel.

AUTO ACK

(For Individual calls with INDIV REPLY set to Auto)

When the radio sounds the incoming DSC call alert:

1. Press the [SILENC] softkey to silence the alert.
2. To see more details about the call, including the requested channel, press ▲ or ▼.
3. You can then use one of the following three softkeys:
 - [ABLE]
Acknowledge the call on the requested channel. The radio will send the acknowledge signal and change to the designated channel.
 - [NEW-CH]
Acknowledge the call, but request a different channel:
 - Press ▲ or ▼ to reach the channel you want to use, and then press the [ABLE] softkey. The radio will send a request for your preferred channel.

→ **Note:** AUTO ACK is not allowed in some EU countries.

- [UNABLE]
Acknowledges the call, but signals that you are unable to use the requested channel. Note: this option is not available for ROUTINE calls. If INDIV REPLY is set to AUTO, the radio will automatically send an acknowledgement to the caller if there is no user intervention within 10 seconds.
- When needed, press [PTT] to talk on the selected working channel.

Receiving a DSC distress call

See “DSC Distress calls” on page 42.

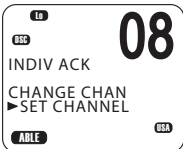
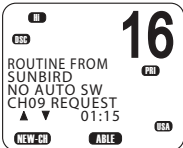
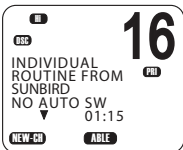
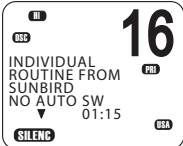

Receiving a DSC individual call

When the radio receives a DSC call, it sounds the alert tone for 2 minutes and displays the priority level and the calling MMSI (or buddy name).

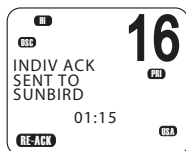
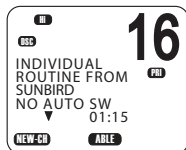
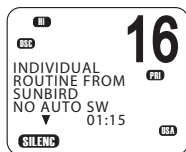

1. Press the [SILENC] softkey to silence the alert.
2. Press ▲ or ▼ to view further information about the call, including the channel requested, or
 - Press [X] to exit without acknowledging.
3. Use the procedures described in “AUTO ACK” on page 58 to acknowledge the call, depending on your radio’s INDIV REPLY settings.
4. The radio will send an acknowledge signal to the calling station.
The radio displays the elapsed time since the incoming call (prior to acknowledgment); or the elapsed time since acknowledgement (after acknowledgment).
5. Press the RE-ACK softkey to send the acknowledgement at any time.
6. The caller should respond to your acknowledgement by making voice contact on the designated channel. If not, you can press PTT to initiate voice contact yourself.

→ Notes:

- The call data is stored in your Call Log (see “Calling using the call log” on page 50).
- For information on sending a DSC individual call, see “Sending an individual DSC Call” on page 46.

Receiving a DSC all-ships call

When the radio receives a DSC call, it sounds the alert tone for 2 minutes and displays the priority level and the calling MMSI (or buddy name).



1. Press the [SILENC] softkey to silence the alert.
2. Press ▲ or ▼ to view further information about the call, including the channel requested, or
 - Press [X] to exit without acknowledging.
3. Use the procedures described in “AUTO SWITCH” on page 57 to acknowledge the call, depending on your radio’s auto switch settings.

4. If appropriate, press PTT to talk on the currently displayed channel.

→ **Notes:**

- The call data will be stored in your Call Log (see “Calling using the call log” on page 50).
- For information on sending a DSC all-ships call, see “Sending an all ships call” on page 49.

Receiving a DSC group call

When a DSC call is transmitted by one of the vessels in a group, all the radios that have the same MMSI entered will receive the message.

When the radio receives a DSC group call, it sounds the alert tone for 2 minutes and displays the priority level (ROUTINE for a group call) and the calling MMSI (or group name).

The radio may change to the requested channel depending on the AUTO SWITCH setting.

1. Press the [SILENC] softkey to silence the alert.
2. Press ▲ or ▼ to view further information about the call.
3. You do not need to send an acknowledgement.
4. If appropriate, press PTT to talk on the designated channel.

→ **Notes:**

- The call data is stored in your Call Log (see “Call Logs” on page 49).
- For information on setting up your group MMSIs see “Creating a group MMSI” on page 96.
- For further information, see “Sending a group call” on page 48.

Receiving a DSC geographic area call

A geographic call is received by vessels within a specific geographic boundary area. The display shows the calling MMSI (or buddy name).

When you receive notification of a GEOGRAPHIC call:

1. Press the [SILENC] softkey to silence the alert.
2. Press ▲ or ▼ to view further information about the call, including the channel requested.
3. Listen to the working channel for an announcement from the calling station.

Receiving a response to a DSC LL request

When you receive GPS data from a buddy in response to your LL request you should make a written note of the position.

1. Press [SILENC] softkey to silence the alert.
 2. Press ▲ or ▼ view further information about the call.
 3. When finished, press [X].
- **Notes:**
- To send an LL request, see “Sending an LL request for the position of a buddy” on page 52.
 - LL request data is not stored on the RS90S.

Receiving a DSC test call

You can set up the radio to respond to incoming DSC TEST calls with an automatic response or manual response. To change the option, see “Setting up DSC test reply” on page 100.

Manual response

1. On receiving a DSC test request, the radio sounds a two-tone alert.
2. Press the [SILENC] softkey to silence the alert.
3. Press the [ACK] softkey to acknowledge the DSC Test Call.

Auto response

On receiving a DSC test request, the radio automatically replies after a 10 second delay with an ACK signal.

ATIS

EU models only.

The Automatic Transmitter Identification System (ATIS) is mandatory for vessels navigating on some European waterways. The system allows authorities to monitor and regulate VHF radio communications by identifying any vessel that makes a VHF transmission. Each vessel is required to have an ATIS-enabled radio on board and is allocated a unique ATIS Maritime Mobile Service Identity (MMSI).

Each time a radio operator finishes talking and releases the PTT key, the radio transmits a short digital message, which includes the ATIS MMSI. The receiving station can then look up details of the vessel, saving time in communication on the busy VHF channels.

Unlike DSC, the ATIS signal is transmitted on the same VHF channel as the voice transmission.

Before you can enable ATIS, you must enter the ATIS MMSI. See "Entering or checking your ATIS MMSI" on page 97.

Before you can enable ATIS, DSC must be turned off. See "Enabling DSC functionality" on page 98. To enable ATIS, see "Enabling ATIS functionality" on page 97.

→ **Notes:**

- ATIS is disabled in US models.
- When ATIS is enabled, the ATIS icon appears on screen.
- In some European countries SCAN functionality is limited, and, if ATIS is enabled, the 3CH SCAN and Dual scan modes will be disabled.

6

AIS procedures

The marine Automatic Identification System (AIS) is a vessel location and information reporting system. It allows vessels to automatically share information such as position, speed, course and identity via a VHF radio link.

The received details of nearby vessels can be displayed on the handset screen together with closest point of approach times and distances. These details are also sent to the NMEA ports for display on a chart plotter if one is connected.

Closest point of approach (CPA) is the calculated closest distance between your vessel and a target vessel based on the current speed and course.

Time to closest point of approach (T/CPA) is the calculated time for a target vessel to arrive at the closest point of approach based on the current speed and course. If the radio detects that another vessel will come closer than the set CPA distance and within the set T/CPA time, the CPA alarm will sound. Both conditions must be met for the CPA alarm to sound.

For information on enabling AIS and setting the CPA time and distance criteria, see "AIS Setup" on page 102.

For general information about AIS, see "Appendix 5 - AIS information" on page 113.

For information on how to configure your chart plotter or software to make use of the RS90S AIS data, see the manual provided with that product.

→ **Notes:**

- Before the AIS functions can be used, the RS90S must receive its own position from a GPS device, or manually entered data.
- The RS90S VHF radio includes an AIS receiver but does not transmit.

To access the AIS displays:

- Press [AIS]
- Repeat press [AIS] to switch between the three available displays:
 - MMSI list (list of nearby vessels)
 - PPI display
 - T/CPA list

From any of the above displays, you can select an MMSI to display details about the particular vessel.

List of nearby vessels

The MMSI list displays a list of vessels within VHF range. As in below example, the list is arranged in ascending order; closest first.

MMSI LIST 1/2		8nM
1 SEASPRAY	225	0.59nM
2 SUNBIRD	275	1.43nM

Each vessel's MMSI (or name, depending on AIS setup) will be displayed, together with its bearing and distance from your position.

PPI display

The Plan Position Indicator (PPI) shows the geographical location of AIS targets with respect to your position, which is represented in the centre of the circular display. See example below:

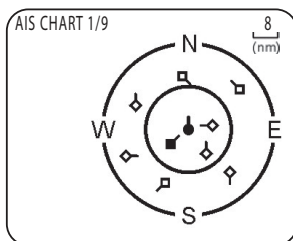

Symbols

- The solid circle in the middle is your vessel.
 - Hollow diamonds represent vessels that are within the current zoom distance.
 - The solid diamond is the selected target vessel.
 - The tails represent course over ground.
- ➔ **Note:** Units on the PPI display are always nautical miles.

To zoom in or out:

- Press [3CH] to zoom in.
- Press [Scan] to zoom out.

Scales available are 1nm / 2 nm / 4 nm / 8 nm / 16 nm / 32 nm.

T/CPA screen

The Time and Closest Point of Approach (T/CPA) screen shows the closest point of approach settings together with a list of vessels that will approach within those criteria.

- CPA alert distance is set up in MENU → AIS SETUP → CPA. (See “Setting up the CPA distance” on page 103.)
- T/CPA alert time is set up in MENU → AIS SETUP → T/CPA. (See “Setting up the T/CPA time” on page 104.)

The approaching AIS target’s details will be listed on the left of the screen.

Once the vessel is within alert distance (CPA) and time (T/CPA), it will be placed in the T/CPA list.

The alert sounds for every vessel within the criteria every time their AIS signal is received.

T/CPA APPROACH

1/9	05:00min	8 nM
-----	----------	------

- In the example above, the criteria are: 5:00 min and 8 nM.

→ Notes:

- The scale on the T/CPA Approach screen is automatically set to the optimum for the selected target. You cannot zoom in or out on this screen.
- If the radio detects a T/CPA or CPA breach, the T/CPA Approach screen will automatically popup with an alert tone. Press [X] to stop the alert; otherwise, the alert will sound again after 1 minute.

AIS target information

From one of the AIS screens, you can display available detailed information about a target vessel:

1. Press ▲ or ▼ to highlight the required target. (Hold down ▲ or ▼ to scroll rapidly.)
2. Press [OK] to view full details of the selected target, including (as an example):

- NAME:
MMSI:
TCPA: 4:39s
CPA: 0.59nM
WIDTH: 26.0m
LENGTH: 158.0m
RECEIVED: 0m33s
CALL SIGN: MYHV6
DRAUGHT:
DIST: 1.01nM
IMO:
BEAR: 155'
HEADING:
ROT: 725.6'/min
SOG: 0.0KTS
COG: 0.0' 55'51.240'N, 012'49.991'E
TYPE: CARGO
NAV STATUS: NOT DEFINED

The display alternates between the first and next page every 5 seconds.

3. When finished, press [X] to exit.

7

Installation

Checklist

The following items are included in the RS90S radio package:

RS90S VHF radio transceiver

- RS90S transceiver unit
- 2 m power supply cable
- 8-pin terminal connector x4
- 2-pin terminal connector x2
- Spare 10 A fuse
- Cable retaining bracket with cable ties and mounting screws
- Transceiver fasteners:
 - M3.5 x 28 mm machine screw x4
 - M3.5 hex nut x4
 - Flat washer x4

Wired handset

- HS90 wired handset with cradle
- 5 m handset connector cable, including mid-cable connector.
- Flush mounting plate for handset connector cable socket
- Silicon cover for cable connector
- Handset fasteners:
 - M3.5 x 15 mm self-tapping screw x2 (cable mounting plate)
 - M3.5 x 10 mm self-tapping screw x2 (top holes)
 - M3.0 x 40 mm self-tapping screw x1 (bottom hole)
 - M3.0 x 40 mm machine screw x1 (bottom hole)
 - M3.5 x 28 mm machine screw x2 (top holes)
 - M3.5 nut x2
 - M3.0 nut x1
 - Assorted spring washers and flat washers

External speaker unit

- External speaker (with 5 m cable)
- Foam gasket (for flush mounting)
- Plastic speaker surface mount box
- Speaker fasteners:
 - M3 x 10 mm self-tapping screw x4 (speaker only)
 - M3 x 10 mm machine screw x4 (speaker only)
 - M3 x 40 mm self-tapping screw x4 (speaker and surface mount box)
 - M3 x 40 mm machine screw x4 (speaker and surface mount box)
 - M3 nut x8
 - Spring washer x8
 - Flat washer x8

Documentation

- User Manual
 - Warranty Card
- **Note:** A VHF antenna is not provided by Simrad. An antenna with a PL259 plug is required. Consult your Simrad dealer for advice if required.

System diagram legend

- 1 RS90S VHF radio transceiver
- 2 12 VDC fused power supply
- 3 HS35 wireless handset (optional - maximum 2 handsets)
- 4 HS90 wired handset (maximum 4 handsets)
- 5 External loudspeaker (maximum 4 speakers)
- 6 NMEA 0183 GPS network connection
- 7 AIS Data output
- 8 Loud hailer speaker (optional)
- 9 VHF antenna with PL259 connector
- 10 NMEA 2000 network connection
- 11 External GPS Antenna (optional)

System overview diagram

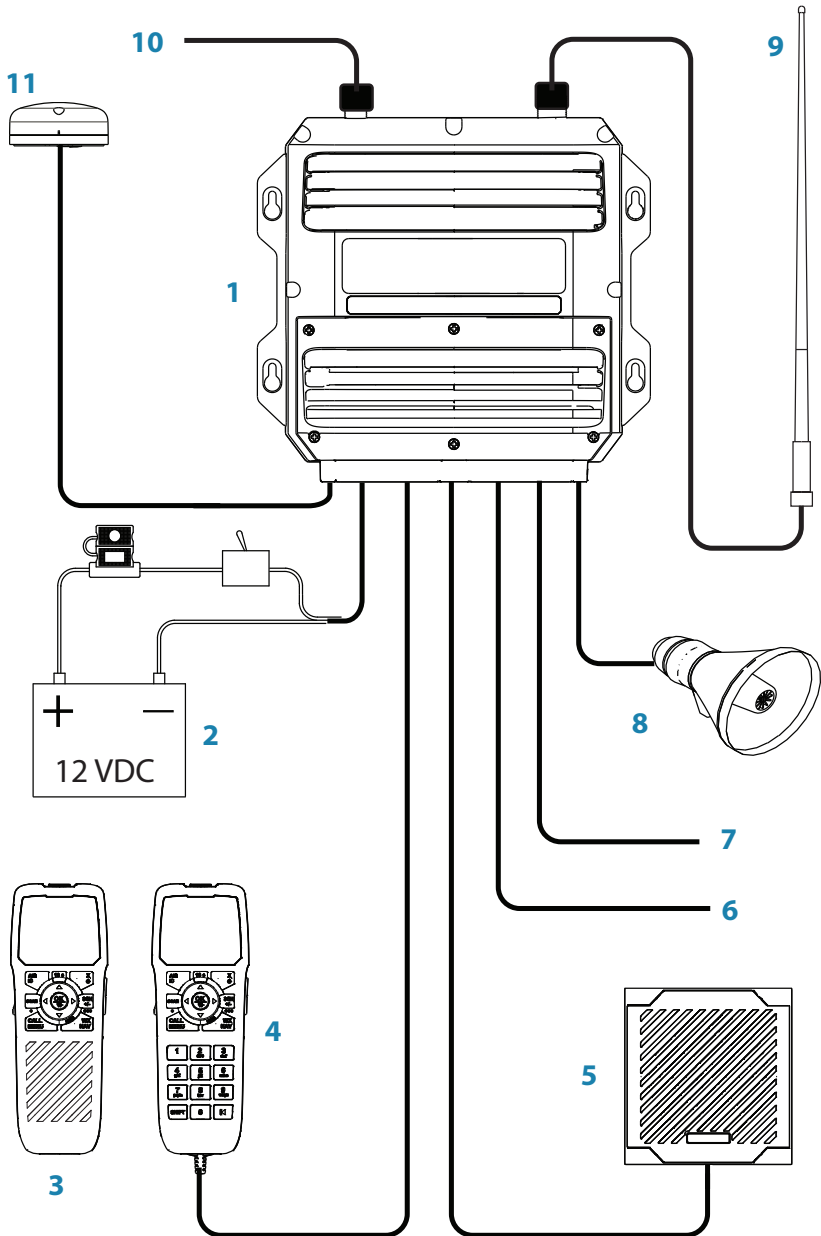

Positioning



Caution: Under extreme operating conditions, the temperature of the rear heat-sink on this radio may reach a surface temperature that is unsafe to touch. Caution is advised to prevent possible skin burns.

RS90S VHF radio transceiver

Make sure that the position of the transceiver:

- Is at least 1 m (39 inches) from the VHF antenna.
- Allows easy connection to the 12 VDC electrical source, the antenna, and the NMEA 2000 connection.
- Is at least 45 cm (18 inches) from any magnetic compass to avoid magnetic deviation of the compass during radio operation.
- Provides suitable space for installing the wired handset cradle(s) nearby. (A 20 m extension cable is available as an optional extra.)
- Provides reasonable access to the wiring via the top panel.

The transceiver can be positioned vertically on a bulkhead or horizontally. Avoid positions that might get wet or hot, such as in the engine compartment or close to the bilge.

Ideally, the transceiver is positioned vertically with the wiring glands facing downwards in order to prevent the ingress of water.

Installing the transceiver

1. Hold the transceiver at the chosen location and mark the 4 hole positions onto the mounting surface.
2. Drill the 4 holes where marked with a drill bit suited to the selected mounting fasteners.
3. Attach the transceiver using the supplied self-tapping screws or machine screws.

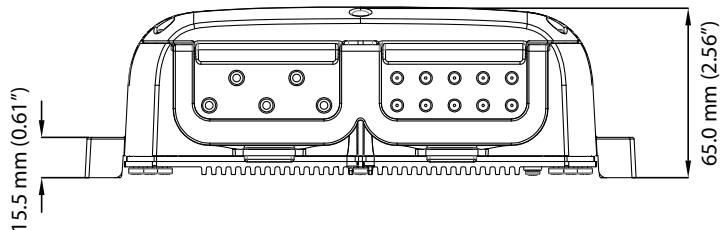
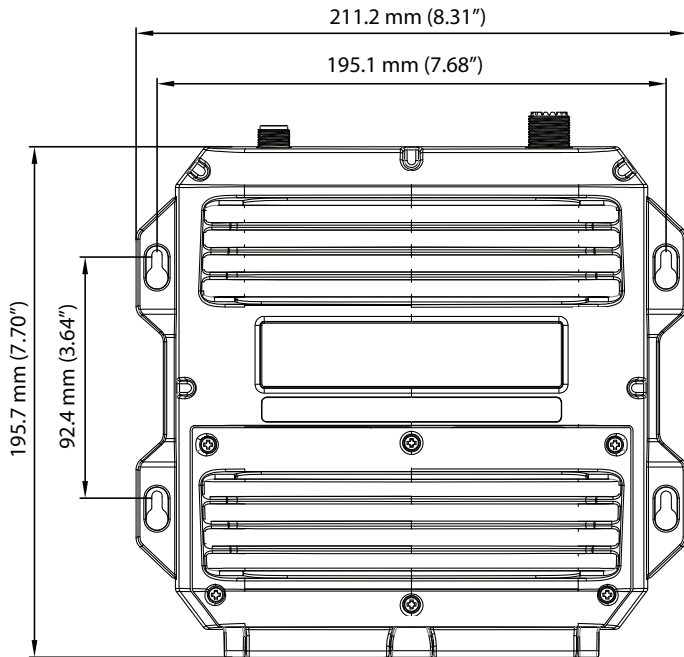

Installing a wired handset cradle

This is the same as installing a wireless handset cradle with the exception that no wiring is required. See "Installing a wireless handset cradle" on page 74.

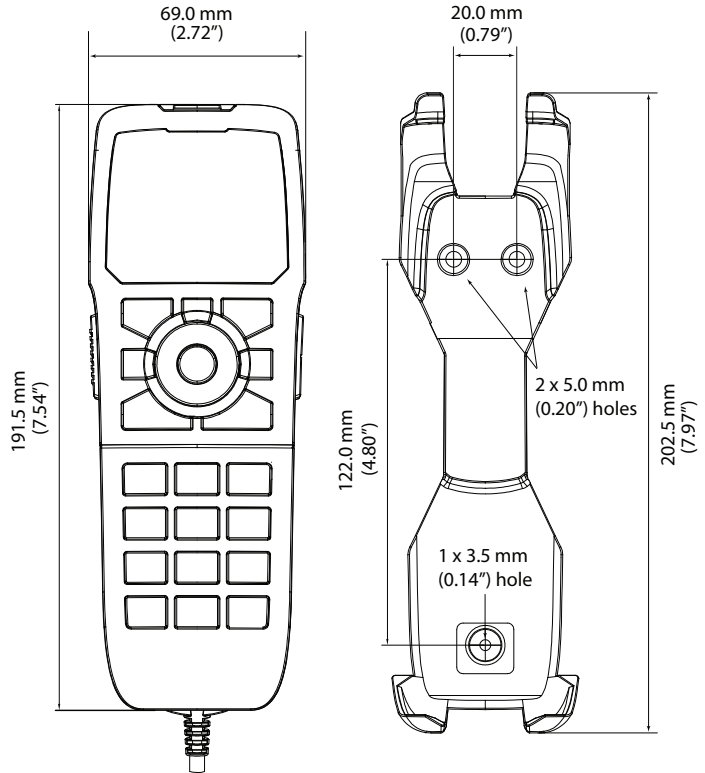

Installing a handset cable connector

Each wired handset cable includes a connector assembly that must be installed in a bulkhead, dashboard or other suitable panel.

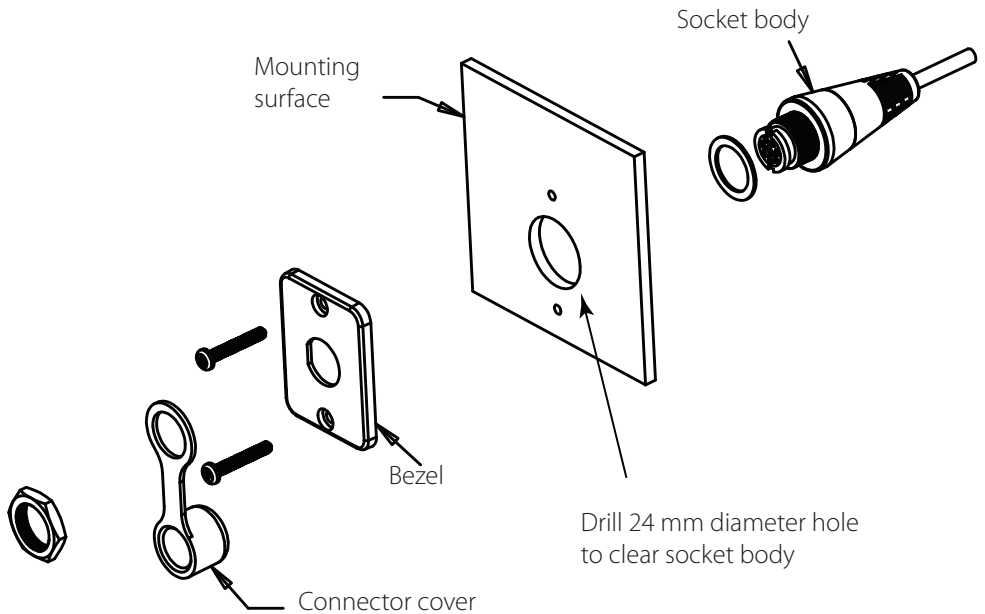

Installing a wireless handset cradle

The wireless handset has a cradle that incorporates inductive charging for the rechargeable battery.

1. Choose a suitable location that provides sufficient room for the handset to fit securely in the charging cradle.
2. Hold the cradle at the chosen location and mark the positions of the fastening holes and the wire hole onto the mounting surface.
3. Drill the holes where marked with a drill bit suited to the selected mounting fasteners.
4. Feed the wire through the wire hole. If mounting outside, apply a suitable sealant or fit a cable gland.
5. Attach the handset cradle using the supplied self-tapping screws or pan head machine screws.
6. Connect the wire to a 12 VDC source via a 1 A fuse:
 - Red wire to 12 VDC positive
 - Black wire to negative.

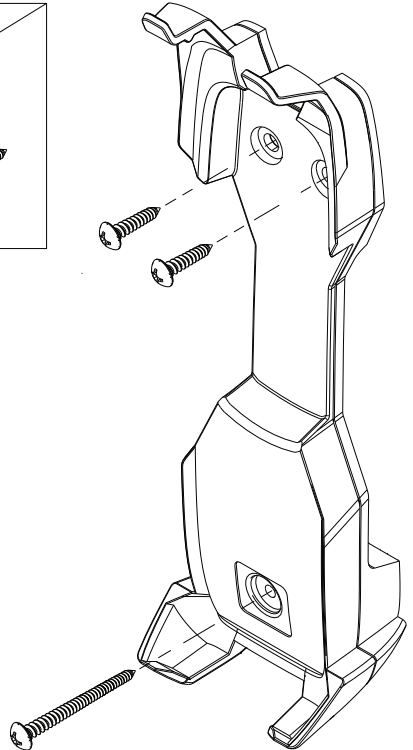
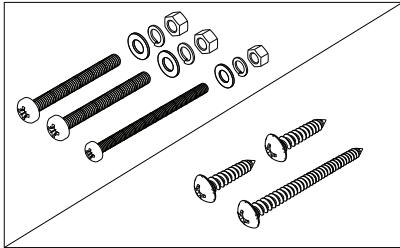

External speakers installation options

Flush mount option

1. Fit the foam gasket to the rear of the speaker and remove the plastic trims that cover the screw holes.
2. Cut a 92 mm (3 5/8") diameter hole in the mounting surface, allowing space for the speaker's overall dimensions.
3. Temporarily fit the speaker and mark the four screw holes.
4. Drill holes of appropriate size for fasteners to be used.
5. Fit the speaker and secure with a small amount of sealant applied to the fasteners.
6. Refit the plastic trim piece.

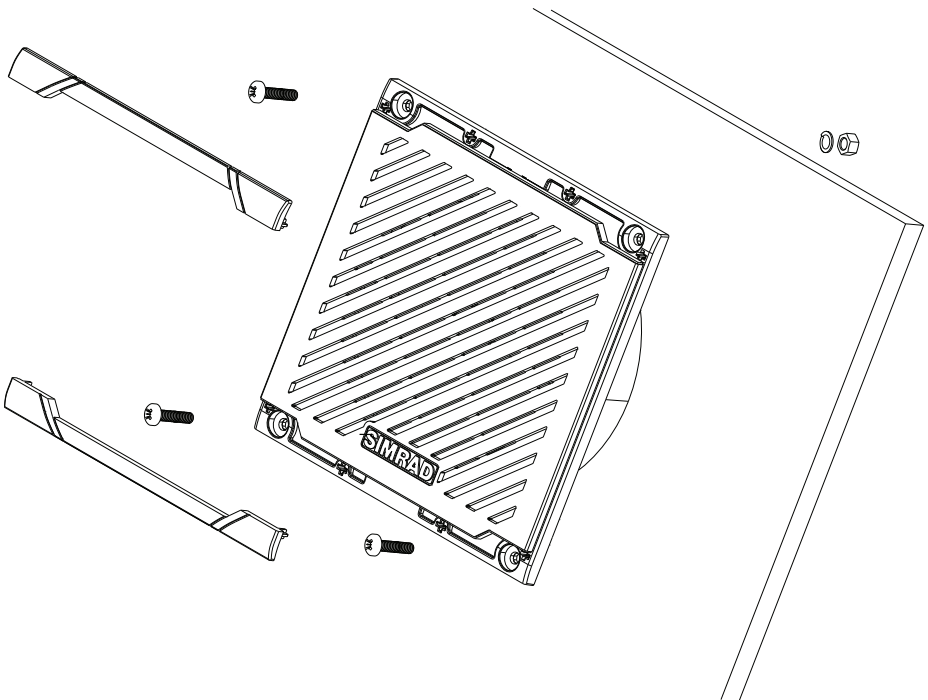

External speaker - surface mount option

1. Position the surface mount box at desired location and mark the four screw holes through the corner tunnels. Make sure the drain hole in box is oriented to be at lowest side.
2. Drill holes of appropriate size for fasteners to be used.
3. Remove the plastic trims that cover the screw holes on speaker front.
4. Drill a hole in the mounting surface for the speaker wire, ensuring hole is near one of the corner screw holes, to prevent cable pinching under speaker.
5. Feed speaker wire through surface mount box and through mounting surface hole.
6. Apply sealant to the cable and around hole.
7. Fix the speaker with fasteners through it and the box, ensuring the logo on speaker and drain hole in box are aligned.
8. Replace the plastic trims.

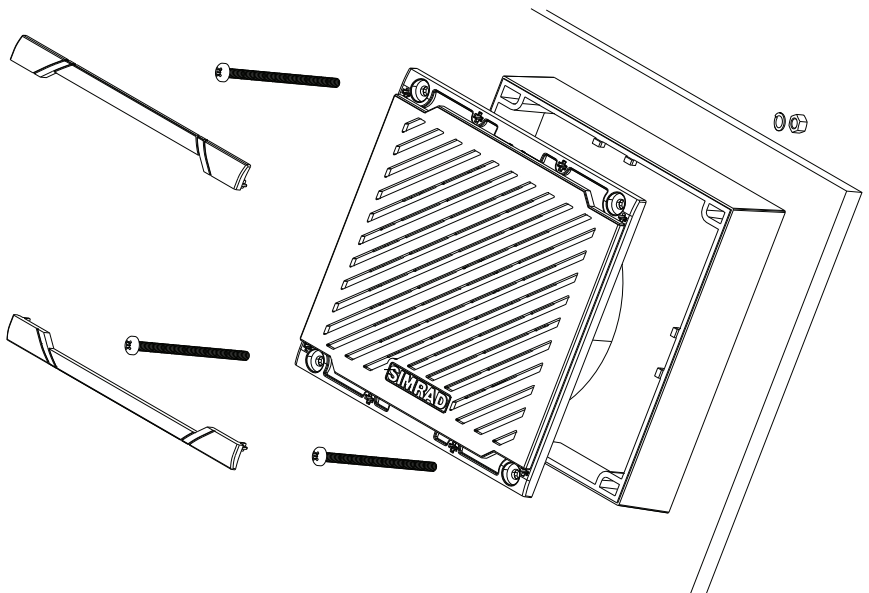

Transceiver external connectors

Connector 13 - VHF antenna

A suitable radio antenna (not supplied) must be mounted and connected with a PL259 connector before you can operate the radio. Consult your Simrad dealer for advice, if necessary.

Always mount the VHF antenna as high as possible and at least 1 m (39 inches) from the transceiver.

Connector 14 - NMEA 2000 (N2K) connector

The RS90S radio can be connected to an NMEA 2000 network using a cable (not supplied). For further information, see “NMEA 2000 Network” on page 83.

→ **Note:** A GPS source is required to enable full functionality of DSC calling, especially DISTRESS calls.

Transceiver internal connectors

To access the internal connectors, remove the cover plate by unscrewing the captive screws. The connectors are on the internal circuit board, which is located as shown below.

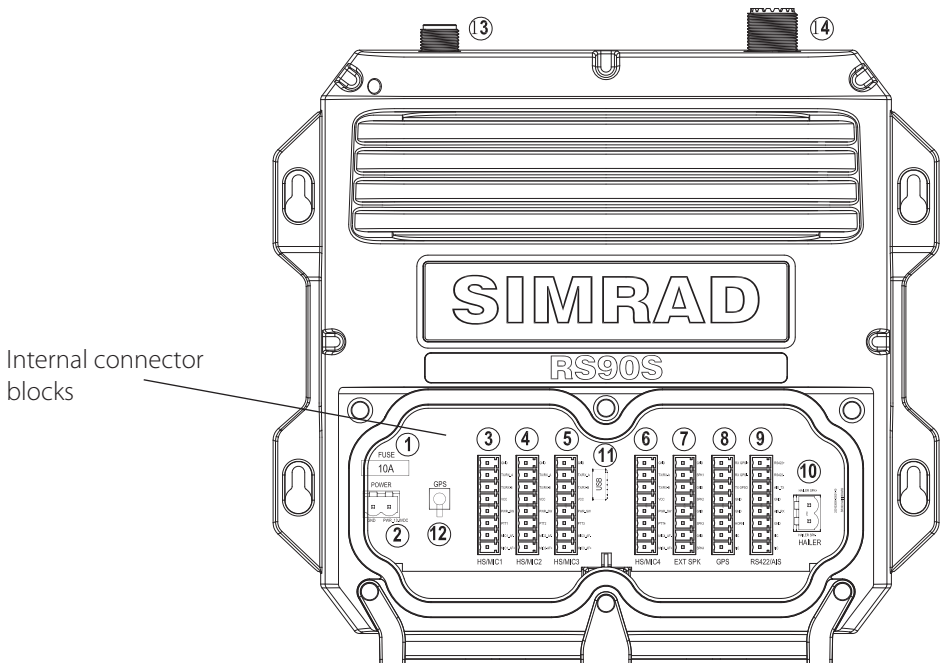

Transceiver internal connector numbering

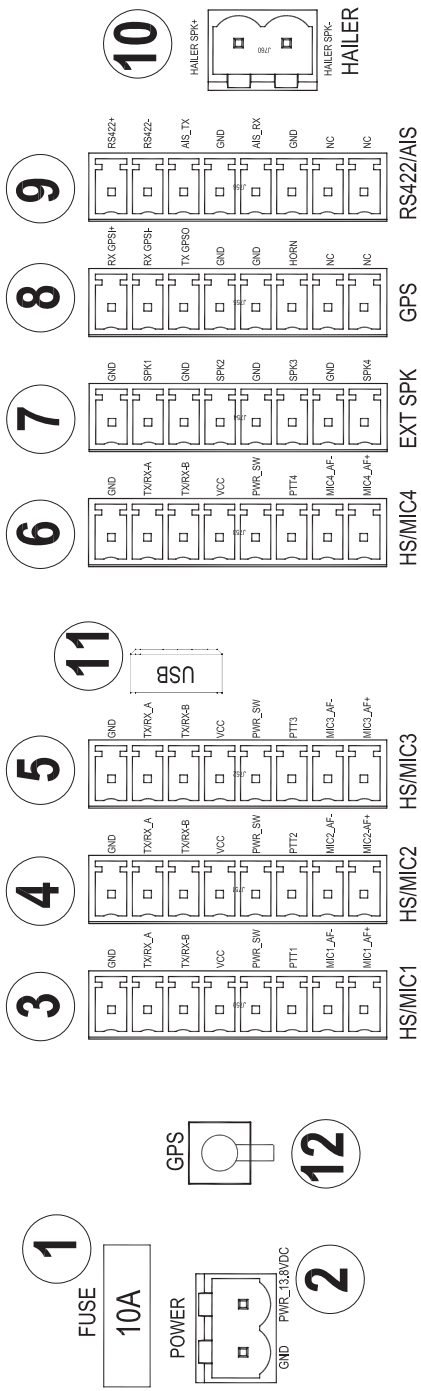

Connector 1 - Fuse

Install a 10 Amp MINI® blade fuse.

Connector 2 - Power connection

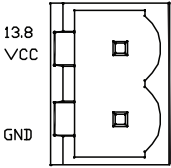

Label	Wire colour
VCC	Red
GND (Negative)	Black

→ Notes:

- Voltage: 12 VDC (10.8 VDC to 15.6 VDC)
- 2 m twin-core power cable is supplied
- If you need to shorten the power cable, ensure that the two ferrite cores are moved and installed on the shorter cable.

Connectors 3, 4, 5 and 6 - Wired handsets

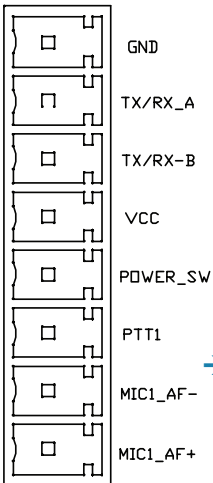

Number	Label	Wire colour
1	GND	Black
2	TX/RX_A	Blue
3	TX/RX_B	Green
4	VCC	Red
5	POWER-SW	White
6	PTT	Grey
7	MIC_AF-	Yellow
8	MIC_AF+	Orange

→ Notes:

- All the necessary wires are included in the handset cable supplied.
- The wired handset cable includes a connector assembly that must be installed in a bulkhead, dashboard or other suitable panel.

Connector 7 - External speakers

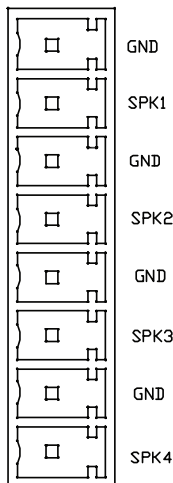

Number	Label	Wire colour
1	GND	Black
2	SPK1	Red
3	GND	Black
4	SPK2	Red
5	GND	Black
6	SPK3	Red
7	GND	Black
8	SPK4	Red

→ Notes:

- You can connect a (minimum) 4W,8 Ω or an 8W,4 Ω speaker to each pair of speaker terminals.
- Speakers are supplied pre-terminated with 5 m twin-core cable (red/black).

Connector 8 - GPS Input - NMEA 0183 (4800 bps), and Horn button connections

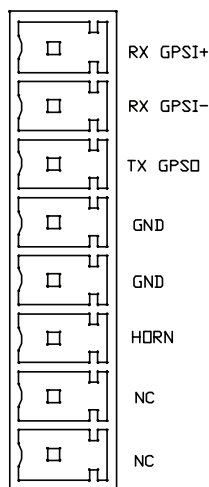

Number	Label	Description
1	RX GPS+	NMEA 0183 Input+ Balanced, RS-422, GPS data input
2	RX GPS-	NMEA 0183 Input- Balanced, RS-422, GPS data input
3	TX GPSO	NMEA 0183 Output+ Connect to ship's NMEA 0183 input
4	GND	NMEA 0183 Output- Single end, GND
5	GND	Wire to horn button
6	HORN	Wire to horn button
7	-	Not connected
8	-	Not connected

→ Notes:

- Use a normally-open horn button.
- A GPS source is required to enable full functionality of DSC calling, especially DISTRESS calls.

Connector 9 - AIS Output NMEA 0183 (38400 bps)

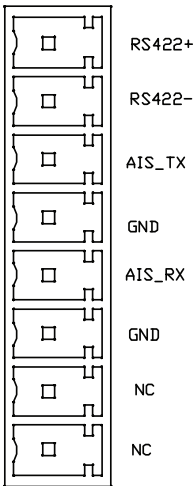

Number	Label	Description
1	RS-422+	Output+ (RS-422 type) AIS RS-422 data output only
2	RS-422-	Output- (RS-422 type)
3	AIS_TX	Output+ (RS-232 type) Connect to PC or chart plotters
4	GND	Output- (RS-232 type)
5	AIS_RX	Not used
6	GND	Not used
7	-	Not connected
8	-	Not connected

Connector 10 - Loud hailer speaker

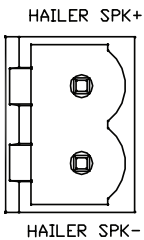

Number	Label	Description
1	HAILER SPK+	
2	HAILER SPK-	

Important: Do not short circuit these 2 pins, as it may cause damage to the radio.

Install the hailer speaker in a forward-facing location on the boat. This is because, in addition to transmitting foghorn sounds, the hailer speaker 'listens back' when not transmitting.

- **Note:** Use a 4-8 ohm speaker or loud hailer horn rated at no less than 30 W. Higher impedance will reduce audio output volume.

Connector 11 - Programming connector

This is a Micro-USB receptacle used for factory diagnostic purposes.

Connector 12 - External GPS Antenna connector

Install the external GPS-500 Antenna (optional)

It is not recommended that the GPS antenna is mounted up a mast where the motion of the vessel will cause the antenna to swing and potentially reduce the accuracy of the GPS position.

Also, do not mount the antenna in the direct path of a radar transmitter.

Mount the GPS-500 to either a pole or hard surface then run the cable to the transceiver. In all cases, ensure the selected location enable the antenna to have a clear, unobstructed view of the sky.

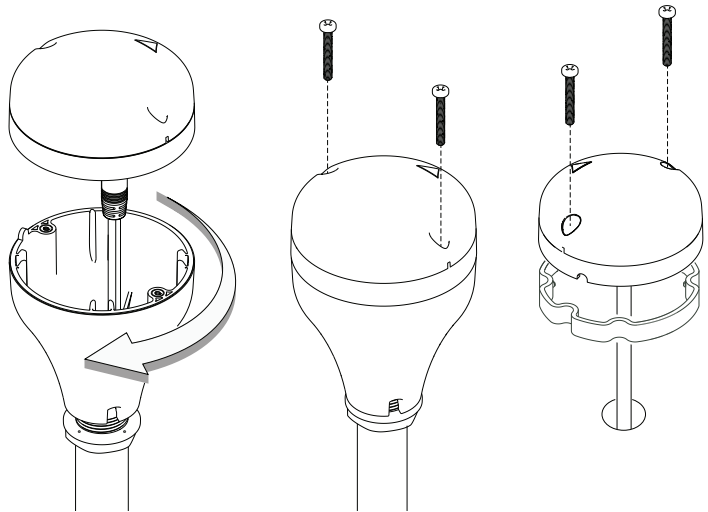

To **pole mount** the external GPS-500 antenna, you will require a 1-inch 14 TPI thread pole:

- Screw the pole adapter onto the threaded portion of the pole.
- Feed the cable attached to the GPS antenna through the adapter and pole.
- Mount the pole into position.
- Fit the GPS antenna to the pole adapter using the 2 small screws.

To **surface mount** the external GPS-500 antenna, select a flat clean surface area that has a clear view of the sky. Mount the antenna using the supplied gasket and the 2 small screws:

- Mark and drill the 2 mounting holes and a further hole if necessary for the GPS cable.
 - Install the gasket by firstly threading the attached cable through the centre of the gasket.
 - Screw the GPS antenna to the mounting surface.
- **Note:** Ensure the surface mounting area is clean with no dirt, old paint or debris.
- Run the GPS cable to the transceiver:
 - Route the cable to your VHF transceiver unit, adding any necessary extension cables.
 - Connect the cable from the GPS antenna to the GPS connector (SMA) on the VHF transceiver as shown in page 77.

Setting up the radio

- **Note:** You must enter your User MMSI before the DSC functions of this radio will work.

For full setup details, see the Setup section in chapter 8.

NMEA 2000 Network

The radio can be connected to an NMEA 2000 network using an NMEA 2000 compliant cable (not supplied).

→ **Notes:**

- The NMEA backbone must be terminated at each end.
- The 'drop' cable to each device must not exceed 6 m.
- Further information on NMEA 2000 is available on the Simrad website.

NMEA 2000 Network Diagram

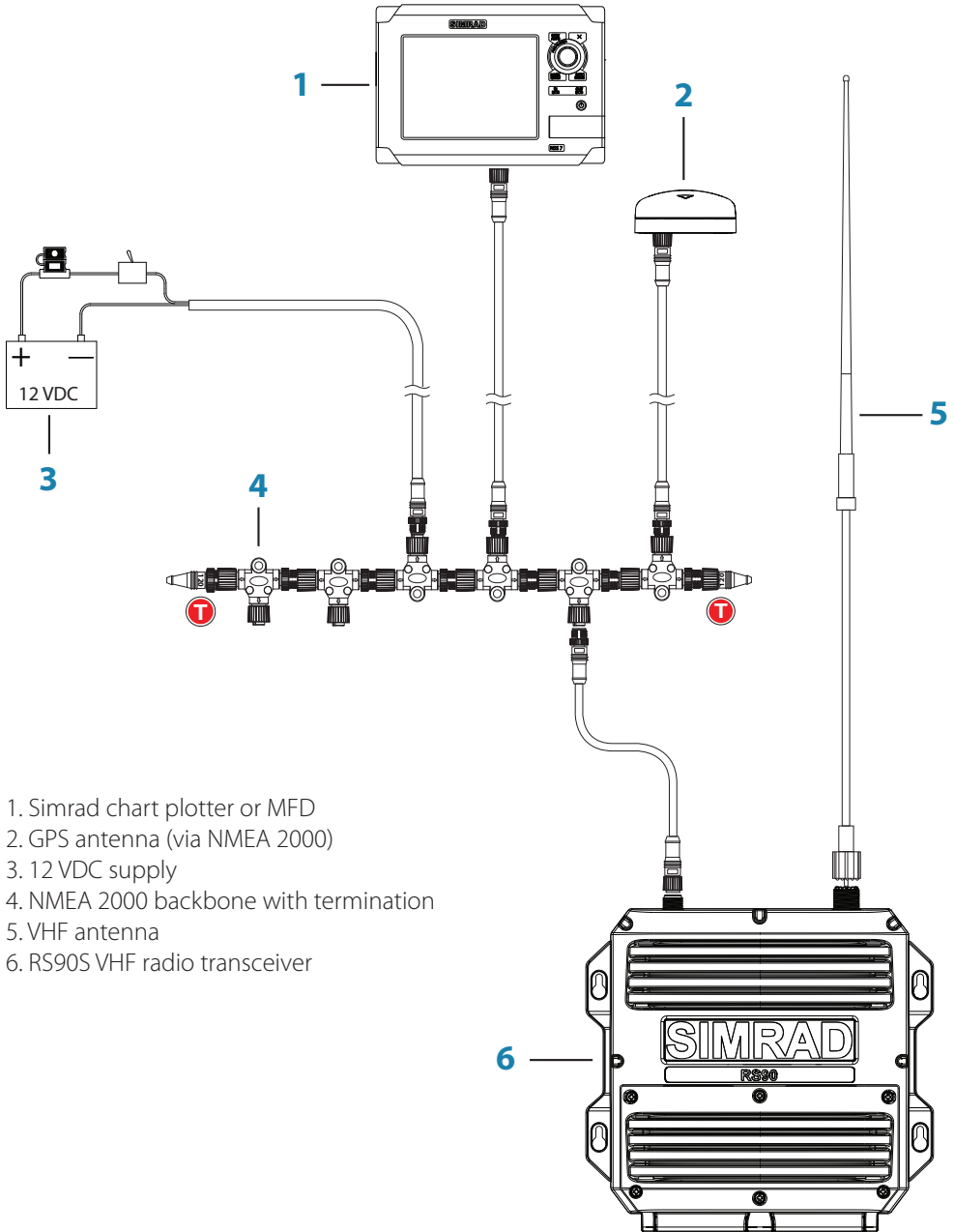

1. Simrad chart plotter or MFD
2. GPS antenna (via NMEA 2000)
3. 12 VDC supply
4. NMEA 2000 backbone with termination
5. VHF antenna
6. RS90S VHF radio transceiver

8

Setup

Wireless handset setup

Subscribing a wireless handset

At installation time, wireless handsets need to be registered in the RS90S transceiver. Once registered, a handset automatically connects to the transceiver when both are switched on. For information about operating the handsets, see “Handsets” on page 12.

1. Make sure the wireless handset is charged and turned OFF.
2. Make sure any other wireless handsets are also turned OFF.
3. On the wired handset, Select MENU → WIRELESS HS → SUBSCRIBE.
4. Select YES. The radio will display WAITING.
5. Turn on the wireless handset. The display will show SEARCHING.
6. Press and hold the [SCAN] on the wireless handset until the display shows REGISTER.

The display will soon show CONNECTING, and then the handset will be registered in the transceiver.

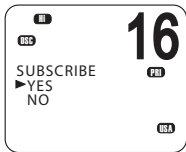
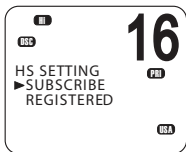
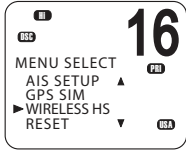

Unsubscribing a wireless handset

To delete an already registered handset:

1. Select MENU → WIRELESS HS → REGISTERED.
2. Select the handset you wish to remove.
3. Select CLEAR <handset name>.
4. Select YES.

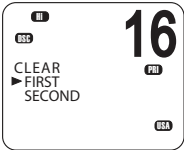
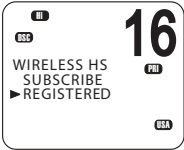
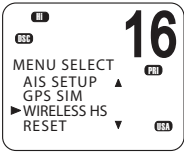

Buddy list setup

The buddy list stores up to 20 contact names and MMSIs. Contact names are stored in the order of entry, with the most recent entry shown first.

Once set up, you can use the buddy list to:

- DSC call an individual buddy; see “Sending an individual DSC Call” on page 46.
- DSC request location of a buddy; see “Sending an LL request for the position of a buddy” on page 52.
- DSC track selected buddies; see “Tracking a buddy - introduction” on page 53.
- DSC Test call; see “Sending a DSC test call” on page 56.

Add a new buddy

You can enter a maximum of 20 buddy names.

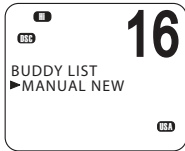
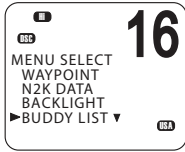

1. Select MENU → BUDDY LIST → MANUAL NEW.
 2. Enter the buddy name, one character at a time up to a maximum of 11 alphanumeric characters.
 3. Press [OK] repeatedly if necessary until the cursor moves to the MMSI entry line.
 4. Enter the MMSI number associated with the buddy name, then press [OK] repeatedly until STORE/CANCEL is displayed.
 5. Scroll to STORE or CANCEL as required and then press [OK].
- **Note:** When the buddy list is full, you cannot make a new entry until you have deleted an existing entry.

Edit or delete a buddy name

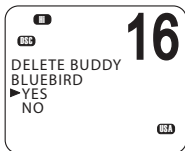
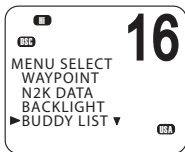

1. Select MENU → BUDDY LIST.
2. Scroll to the required entry and press [OK].
3. To edit the buddy, select EDIT, and then:
 - Edit the buddy name, or
 - To edit only the MMSI, press [OK] repeatedly until the cursor moves to the MMSI line.
 - When finished editing, press [OK] repeatedly if necessary until STORE/CANCEL appears.
 - Scroll to STORE or CANCEL as required and then press [OK].

To delete a buddy:

- Select DELETE at step 3, and then YES. The buddy will be deleted from the list immediately.

Radio setup

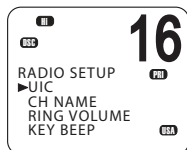
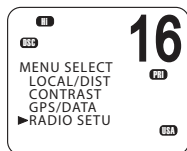

UIC

US and AUS models only.

This option allows you to switch between USA, International, or Canadian channel banks. The selected channel bank is displayed on the LCD along with the last used channel. For details of channel banks, see “Appendix 7 - Channel charts” on page 119.

1. Select MENU → RADIO SETUP → UIC.
2. Select the desired channel bank then press [OK].

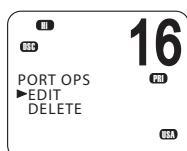
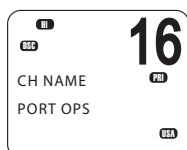
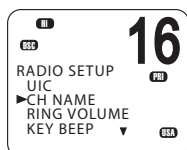
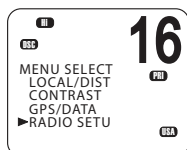

Editing channel names

If a channel has been assigned a name, the name appears next to the channel number on the standby screen. You can edit or delete the channel names.

A list of default channel names is given in “Appendix 7 - Channel charts” on page 119.

1. Select MENU → RADIO SETUP → CH NAME.
2. Use ▲ and ▼ to scroll to the one you want to change then press [OK].
3. Select EDIT.
4. Enter the new name over the existing one.
5. Press [OK] repeatedly if necessary to display the YES/NO confirmation.
6. Scroll to YES or NO as required and press [OK].

To delete a channel name:

Use a similar procedure to the above, but select DELETE at step 3.

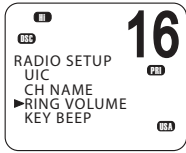

Ring volume

The radio sounds a two-tone alert when it detects an incoming DSC call. You can change the volume level.

1. Select MENU → RADIO SETUP → RING VOLUME.
2. Scroll to HIGH or LOW as required, then press [OK].

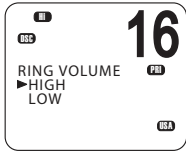

Key beep

You can change the key beep volume or turn the key beeps off completely.

1. Select MENU → RADIO SETUP → KEY BEEP.
2. Scroll to the required setting: ON or OFF, then press [OK].

→ **Note:** The key beep setting is separate for each handset.

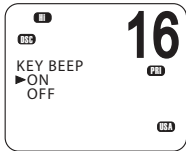
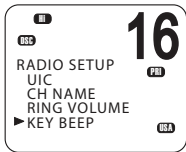

Units

You can select your preferred measurement units for distance and cross-track error (for waypoint navigation).

1. Select MENU → RADIO SETUP → UNITS.
2. Scroll to the required measurement units: METRIC, NAUTICAL or STATUTE, then press [OK].

→ **Note:** Nautical Miles is the only unit available in AIS mode.

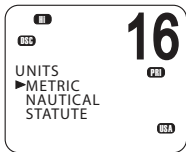
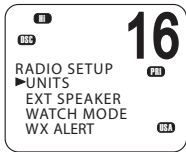

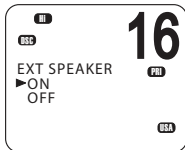

External speaker

You can switch the external speaker ON or OFF.

1. Select MENU → RADIO SETUP → EXT SPEAKER.
2. Scroll to ON or OFF as required, and then press [OK].

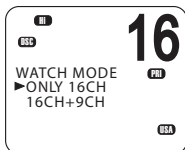
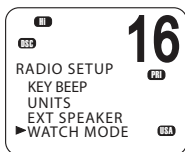

Setting the priority channel

US model only.

If you are operating on the USA or Canadian channel banks, you can set the radio to scan CH16 and CH9 as well as the working channel.

1. Go to menu option RADIO SETUP → WATCH MODE.
2. Select one of the two options:
 - 16CH to enable Channel 16 only, or
 - 16CH+9CH to enable both Channel 16 and Channel 9.

This setting affects Dual Watch and Tri watch modes.

When watch mode is only channel 16:

- The [16/9] key switches to channel 16.
- Short press [SCAN] enters dual-watch mode.
- Long press [SCAN] scans all available channels.

When watch mode is channel 16 and channel 09:

- Short press the [16/9] key switches to the current priority channel.
- Long press the [16/9] key toggles the priority channel between CH16 and CH09.
- Short press [SCAN] enters tri-watch mode.
- Long press [SCAN] scans all available channels.

For further information, see:

- "Priority channels" on page 21.
- "Dual watch scan" on page 31.
- "Tri watch scan" on page 32.

Setting up a favourite channel

Non-US models only.

The WX key can be programmed to a channel of your choice so that you have quick access to that channel. For further information, see “Favourite channel (non-US models)” on page 28.

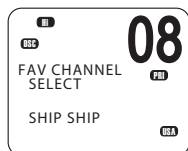
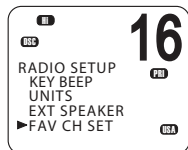

1. Select MENU → RADIO SETUP → FAV CH SET.
2. Use the ▲ and ▼ keys to select the required channel, and then press [OK].

→ Notes:

- For US models, the WX key has a different purpose. See “Receiving weather alerts (US model only)” on page 27.
- You can store just one favourite channel.

Setting up weather tone alert

US model only.

1. Select MENU → RADIO SETUP → WX ALERT → TONE ALERT.
2. Select ON or OFF as required.

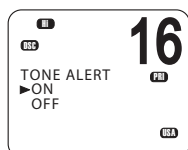
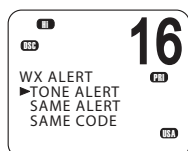
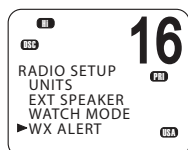

Tone alert ON.

- If an alert tone is broadcast from the NOAA weather station, the weather alert is picked up automatically and the alarm sounds. Press any key to cancel the alarm and to hear the weather alert message.
- The Weather alert symbol will be displayed on screen to show that the weather alert tone setting is on.

Weather alert symbol: 

Tone alert OFF

With this setting, the radio ignores weather alerts.

Setting up SAME alert

US model only.

- **Note:** SAME ALERT works only after you have entered and selected a SAME code for your geographic area (see “Entering a SAME code” on page 92).



For usage, see “Receiving SAME alerts (US model only)” on page 27.

1. Select MENU → RADIO SETUP → WX ALERT → SAME ALERT.
2. Select On or OFF as required.

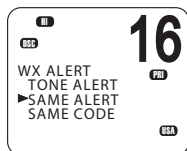

- **Note:** SCAN mode will operate up to 50% more slowly when SAME ALERT is ON to allow time to decode the special warning code transmissions.

SAME alert ON

- The radio will receive any local NWR or EAS alerts.
- The SAME icon will be displayed on screen to show that the SAME alert setting is on.

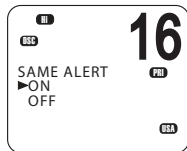

SAME alert OFF

With this setting, the radio ignores SAME weather alerts.

Entering a SAME code

US model only.

Before you can receive SAME weather alerts, you must enter and then select a SAME code for your geographic area into the radio.

To find the SAME codes for your geographic area:

- Telephone 1-888-NWR-SAME (1-888-697-7263), or
- Visit www.nws.noaa.gov/nwr/indexnw.htm

1. Select MENU → RADIO SETUP → WX ALERT → SAME CODE.

If you have already entered some SAME codes, they will be listed.

2. Select NEW CODE. Enter the new SAME code along the dashed line, one number at a time.
3. When prompted, select STORE and press [OK] to store the SAME code.

Repeat if necessary to enter a maximum of 10 SAME codes.

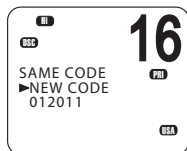
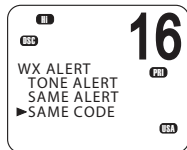

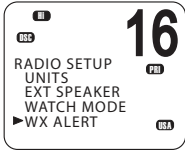

Selecting a working SAME code

US model only.

In order to receive SAME weather alerts, you must select a SAME code that you have previously entered into the radio.

1. Select RADIO SETUP then WX ALERT → SAME CODE.
2. If you have already entered some SAME codes, they will be listed.
3. Select the SAME code for your geographic area.

Choose SELECT CODE. Then select YES.

Selected SAME codes are displayed with the word 'ON' next them in the list

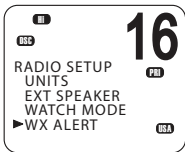
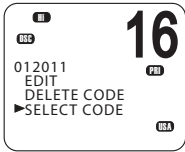
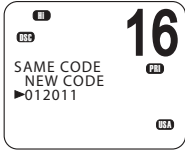
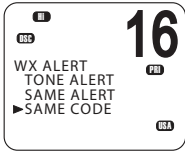

Editing or deleting a SAME code

US model only.

1. Select RADIO SETUP → WX ALERT → SAME CODE.
2. If you have already entered some SAME codes, they will be listed.
3. Select the SAME code for your geographic area.
4. Select EDIT or DELETE as required.

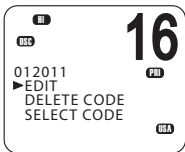
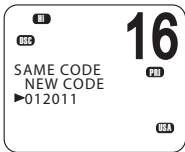
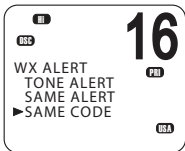

Selecting the GPS source

A valid GPS connection is required for DSC to function. The RS90S radio can use either its internal GPS system or an external GPS source.

The internal GPS system requires an external GPS antenna to be installed. Installation instructions can be found in the RS90S Installation Manual.

External GPS sources can be derived from either NMEA 0183 or NMEA 2000 protocol to receive GPS data from a compatible GPS unit. Up to 4 sources can be connected.

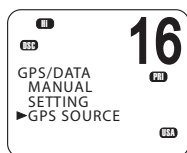

1. Select GPS/DATA →GPS SOURCE.
2. Select the required GPS source, and then press [OK].

→ **Note:** NMEA 2000 SOURCE options will appear only if an NMEA 2000 network is connected to the radio and is operational.

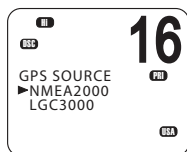

Data / Source

LEVEL-2	LEVEL-3	Function	Options
GPS	SETTING	TIME OFFSET	+00:00
		TIME FORMAT	12 HR/24 HR
		TIME DISPLY	ON/OFF
		LL DISPLY	ON/OFF
		COG/SOG	ON/OFF
		GPS ALERT	ON/OFF
	GPS SOURCE	MANUAL	SET LAT / LON / TIME
		NMEA 2000	AUTO SELECT
			N2K-1
			N2K-2 etc. ...
		NMEA 0183	Set checksum (ON/OFF)
		INTERNAL GPS	Select
	GPS SIM	Set GPS simulator mode	ON/OFF
DEPTH	NONE		
	...		

DSC Setup

Entering or viewing your individual MMSI

The user MMSI (Marine Mobile Service Identity) is a unique 9 digit number, similar to a personal telephone number. It is used on marine transceivers that are capable of using the DSC system.

Contact the appropriate authorities in your country to obtain your user MMSI.

→ Notes:

- Entering the MMSI is a once-only operation. You can display and read your user MMSI at any time, but you can only enter it once.
- Enter the number carefully before pressing [OK] the second time. If you make a mistake, the radio will have to be sent back to the dealer to be reset.
- Your MMSI is also shown on the startup screen when you power on the transceiver.

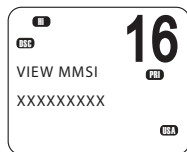
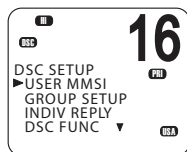
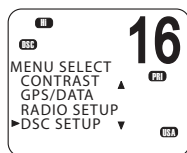

1. Select MENU → DSC SETUP → USER MMSI.

If you have already entered your MMSI, it will be shown on screen.

If you are entering your MMSI, a dashed line appears.

2. Enter your MMSI along the dashed line, one number at a time.
3. Press [OK] to store your user MMSI.
4. Enter your user MMSI again as a password check, then press [OK] to permanently store the user MMSI.

Introduction to group MMSI

A group MMSI is a shared MMSI. When a DSC call is transmitted by one of the vessels in the group, all the radios that have the same MMSI entered will receive the message.

The RS90S radio can store up to 20 group MMSIs. In other words, you can be in 20 different groups.

A group MMSI always starts with 0.

For information on sending a DSC group call, see "Sending a group call" on page 48.

Creating a group MMSI

1. Select MENU → DSC SETUP → GROUP SETUP.

2. Select MANUAL NEW.

If this is the first time that you are entering a group name, a dashed line appears.

3. Enter the group name along the dashed line. It can be a maximum of 11 alphanumeric characters.

4. Press [OK] repeatedly if necessary to reach the MMSI line.

5. Enter the group MMSI. The first number is always a 0.

6. Press [OK] repeatedly until STORE/CANCEL is displayed.

7. Select STORE or CANCEL as required.

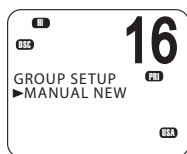
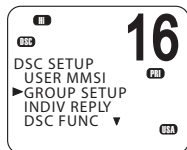
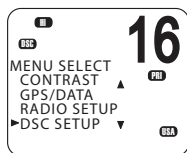

Editing or deleting a group MMSI

1. Select MENU → DSC SETUP → GROUP SETUP.

The display shows the list of existing group names.

2. Scroll to the group you want to edit and press [OK].

- To delete the group, select DELETE then YES. The group will be deleted immediately.
- To edit the group, select EDIT.

3. Edit the group name as required.

4. Press [OK] repeatedly if necessary until the cursor moves to the MMSI line.

5. Edit the MMSI. (Note that the first number is always a 0.)

6. Press [OK] repeatedly until STORE/CANCEL is displayed.

7. Scroll to STORE or CANCEL as required and press [OK].

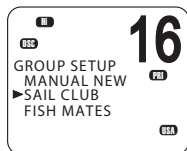
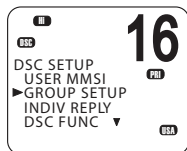
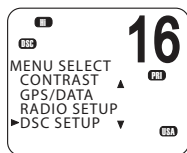

Entering or checking your ATIS MMSI

EU models only.

The ATIS MMSI is a special MMSI that is used on inland waterways in Europe for identifying the ship or vessel that made a VHF radio transmission. The MMSI is transmitted on the VHF channel each time the radio operator finishes talking and releases the PTT key. For further information, see “ATIS” on page 62.

→ Notes:

- You can display and read your ATIS MMSI at any time, but you can only enter it once.
- Enter the number carefully before pressing [OK] the second time. If you make a mistake, the radio will have to be sent back to the dealer to be reset.

1. Select MENU → DSC SETUP → ATIS MMSI.

If you have already entered your ATIS MMSI, it is shown on screen.

If you are entering a new ATIS MMSI, a dashed line appears.

2. Enter your ATIS MMSI along the dashed line, one number at a time. An ATIS MMSI always starts with the number 9.
3. Press [OK].
4. Enter your ATIS MMSI again as a password check, then press [OK] to permanently store the ATIS MMSI.

Enabling ATIS functionality

EU models only.

1. Select MENU → DSC SETUP → ATIS SELECT.
2. Scroll to ON or OFF as required and press [OK].

→ Notes:

- Before you can enable ATIS, you must enter an ATIS MMSI. See “Entering or checking your ATIS MMSI” above.
- Before you can enable ATIS, DSC must be turned off. See “Enabling DSC functionality” on page 98.
- When ATIS is enabled, the ATIS icon is displayed on screen.
- In some European countries, SCAN functionality is limited, and, if ATIS is enabled, the 3CH SCAN mode will be disabled.

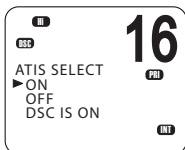
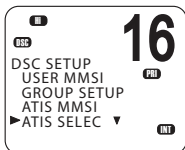
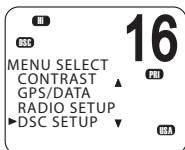
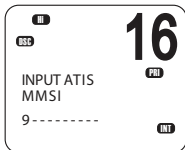
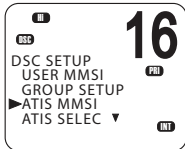
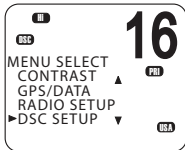

Individual DSC call - reply options

The reply to an incoming DSC individual call can be automatic or manual.

- An automatic reply sends an acknowledgement and then sets the requested working channel, ready for a conversation.
 - A manual reply prompts you to acknowledge the call.
1. Select MENU → DSC SETUP → INDIV REPLY.
 2. Scroll to MANUAL or AUTO as required and press [OK].

For information on receiving an individual DSC call, see “Receiving a DSC individual call” on page 59.

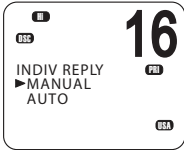
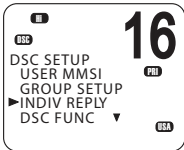
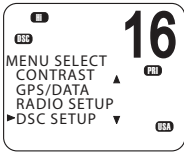

Enabling DSC functionality



Warning: DSC is an important safety function; disabling it is not recommended.

DSC is only available after a valid USER MMSI has been entered. For instructions on entering your MMSI, see “Entering or viewing your individual MMSI” on page 95.

1. Select MENU → DSC SETUP → DSC FUNC.
2. Scroll to ON or OFF as required and press [OK]

→ Notes:

- It is not possible to have both ATIS and DSC on at the same time. If you want to enable DSC, you must first switch ATIS off.
- When DSC functionality is selected, the  icon is displayed on screen.

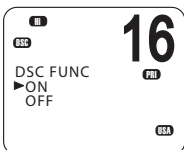
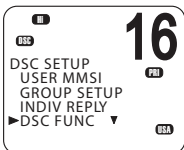
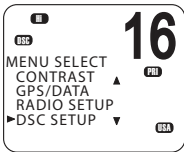

LL polling calls - reply options

A DSC LL polling call is received by the radio when one of your buddies sends a request for your position—latitude and longitude request (LL request)—normally at regular intervals.

For information on LL requests (polling) see “Sending an LL request for the position of a buddy” on page 52.

You can set up the radio to respond to an LL polling request in one of three ways:

- **MANUAL**
Reply manually to any incoming LL polling requests.
- **AUTO**
Automatically reply to any incoming LL polling requests.
- **OFF**
Ignore all incoming LL polling requests.

1. Select MENU → DSC SETUP → LL REPLY.
2. Scroll to MANUAL, AUTO or OFF as required and press [OK].

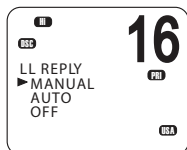
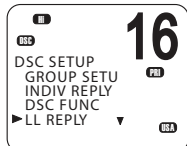
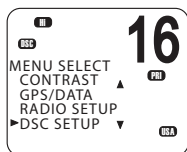

Automatic channel switch options

When a DSC call is received, it may include a request to change to a specific channel for subsequent communications.

With Auto Switch set to ON, when receiving a DSC call, the radio will automatically switch to the requested channel if not cancelled within 10 seconds. This might disrupt important communications that are already in progress on the current working channel. To avoid this, you can prevent the radio from automatically switching channel by setting the AUTO SWITCH feature to OFF.

If Auto Switch is set to OFF, the  icon will be displayed on screen to remind you that this feature is set to off.

Additionally, the text “AUTO SW OFF” will be included in an All Ships or Group call.

To enable or disable automatic channel switching:

1. Select MENU → DSC SETUP → AUTO SWITCH.
2. Scroll to ON or OFF as required and press [OK].

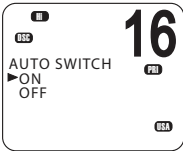
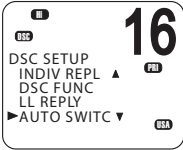
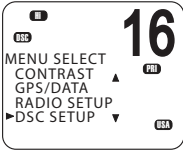

Setting up DSC test reply

You can set up the radio to respond to incoming DSC TEST calls with an automatic or manual response.

1. Select MENU → DSC SETUP → TEST REPLY.
2. Scroll to AUTO or MANUAL as required and press [OK].

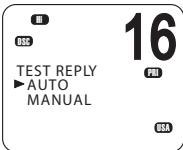
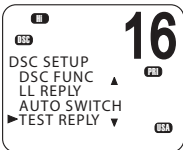
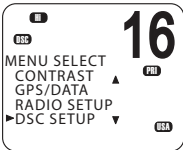

- **AUTO**
On receiving a DSC TEST call, waits for 10 seconds, and then automatically acknowledges the call.
- **MANUAL**
On receiving a DSC TEST call, requires you to press the [ACK] soft key to acknowledge the call.

For information on receiving a DSC test call, see “Receiving a DSC test call” on page 61.

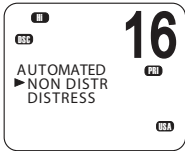
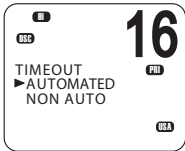
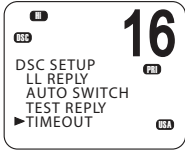
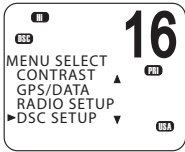

Setting up the DSC inactivity timer

The inactivity timer causes the radio to automatically exit a procedure after a specified period of inactivity.

AUTOMATED

You can set the radio to exit any automated procedure after a period of non-activity.

There are two categories:

- DISTRESS options: NO TIMEOUT, 5 MINS, or 10 MINS
- NON-DISTR options: NO TIMEOUT, 10 MINS, or 15 MINS

1. Select MENU → DSC SETUP → TIMEOUT → AUTOMATED.
2. Select NON DISTRESS or DISTRESS.
3. Scroll to the required timeout period, and then press [OK]

NON AUTO

You can set the radio to exit any non-automated procedure after a period of non-activity.

1. Select MENU → DSC SETUP → TIMEOUT → NON AUTO.
2. Scroll to the timeout period: NO TIMEOUT, 10 MINS or 15 MINS, then press [OK]

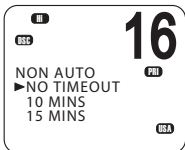
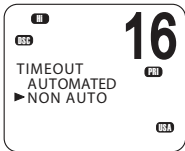
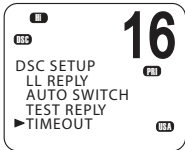

AIS Setup

→ **Note:** The wired HS has a shortcut key to access AIS SETUP (Shift 2).

Enabling AIS functionality

1. Select MENU → AIS SETUP → AIS FUNC.
2. Scroll to ON or OFF as required and press [OK].

→ **Note:** When AIS functionality is enabled, the **AIS** icon is shown on screen.

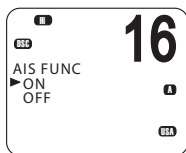
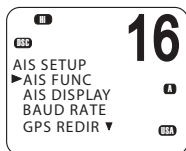
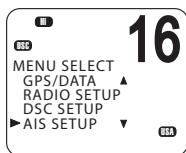

Setting up AIS display format

When viewing the PPI screen, AIS targets can be displayed with the vessel's name or MMSI.

1. Select MENU → AIS SETUP → AIS DISPLAY.
2. Scroll to SHIP MMSI or SHIP NAME as required and press [OK].

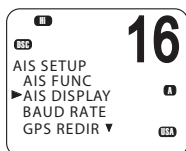
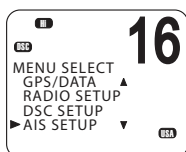

Setting up AIS baud rate

AIS data can be output to a compatible chart plotter, multi-function device (MFD) or PC via the NMEA port.

The NMEA port baud rate can be set to 4800 or 38400. The default setting is 38400. If 4800 is selected, a warning that data may be lost will be displayed.

1. Select MENU → AIS SETUP → BAUD RATE.
2. Scroll to 4800 or 38400 as required and press [OK].

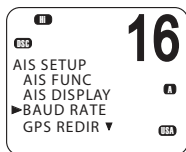
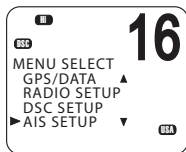

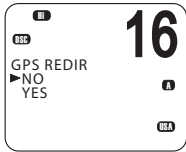
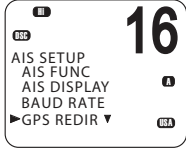
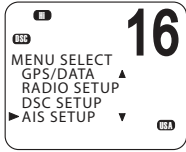

GPS REDIR

GPS redirection option set to output the GPS information to the chart plotter, eliminating the need for an additional multiplexer.

1. Select MENU → AIS SETUP → GPS REDIR.
 2. Scroll to YES or NO as required and press [OK].
 - If you select YES, the string \$RMC will be redirected to the chart plotter once it is received.
- **Note:** The REDIR function will only redirect RMC and GLL messages from NMEA 0183 input port to the AIS output port.

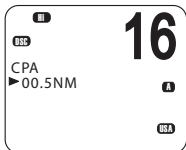
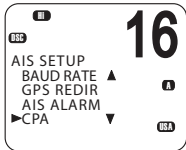
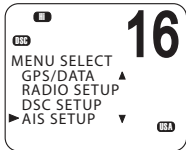

Setting up the CPA distance

Closest point of approach (CPA) is the calculated closest distance between you and a target vessel based on the current speed and course.

If the radio detects that a target vessel will come closer than the set distance and within the set T/CPA time, the CPA alarm will sound a two-tone alert.

1. Select MENU → AIS SETUP → CPA.
 2. Use the ▲ and ▼ keys to raise or lower the CPA distance limit.
 3. Press [OK].
- **Note:** The CPA distance is always in nautical miles.

Enabling the CPA alarm

You can enable or disable the CPA alarm.

1. Select MENU → AIS SETUP → CPA ALARM.
2. Scroll to ON or OFF as required, and then press [OK].

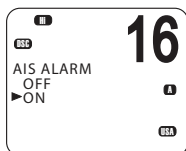
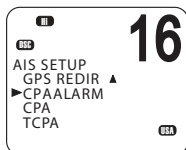
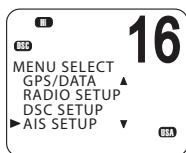

Setting up the T/CPA time

Time to closest point of approach (T/CPA) is the calculated time for a target vessel to arrive at the closest point of approach based on the current speed and course.

If the radio detects that a vessel will arrive at the closest point of approach within the set time and the CPA distance, the CPA alarm will sound a two-tone alert.

1. Select MENU → AIS SETUP → TCPA.
2. Use the ▲ and ▼ keys to raise or lower the T/CPA time limit.
3. Press [OK].

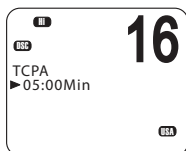
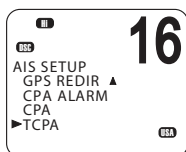
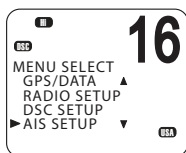

GPS setup

If a GPS receiver is connected to the NMEA port of the RS90S, the radio will automatically receive the vessel's position and local time from the GPS.

If GPS data is not available for some reason, the radio will sound the NO GPS alert for 2 minutes (or until you press any key).

If the GPS data becomes older than 4 hours, the NO GPS alert will sound, and it can only be silenced manually or by the reception or manual entry of new GPS data.

If the vessel's GPS data is older than 23.5 hours, the data will be erased and the NO GPS alert will sound.

Manually entering position and UTC time

→ **Note:** this function is only shown when there is no GPS receiver connected.

1. Select MENU → GPS/DATA → MANUAL.
2. Enter the latitude, then the longitude, then the UTC.

When you have finished, the latitude, longitude and UTC time will be shown on the standby screen. The prefix M indicates a manual entry.

→ **Notes:**

- Manual entries are cancelled if a real GPS position is received.
- A warning will be displayed after 4 hours to remind you that the current position information was manually entered.

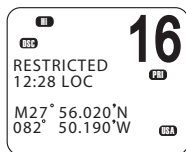
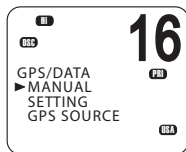
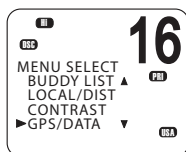

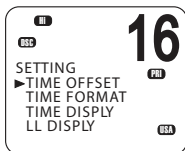
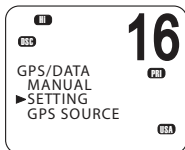
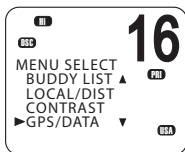

Setting up local time offset

If your position and time data are being updated through a GPS receiver, you can enter the time difference between UTC and local time. Then the local time will be displayed on the screen.

1. Select MENU → GPS/DATA → SETTING → TIME OFFSET
 2. Enter the difference between UTC and local time.
You can set in quarter-hour increments up to a maximum offset of ± 13 hours.
- **Note:** When local time is being displayed, LOC is displayed after the time on the standby screen.

Time format options

Time can be shown in 12 or 24 hour format.

1. Select MENU → GPS/DATA → SETTING → TIME FORMAT.
 2. Select 12- or 24-hour as required.
- **Note:** When the 12-hour format has been selected, the time is displayed with an AM or PM suffix.

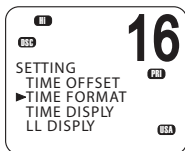
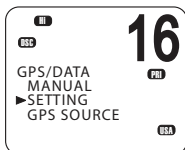

Time display options

You can toggle on or off the time display on the handset screens.

3. Select MENU → GPS/DATA → SETTING → TIME DISPLY.
4. Select ON or OFF as required.

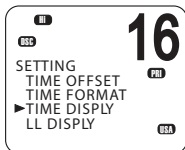
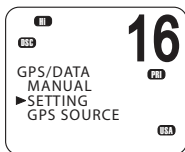

Position display options

You can display or hide your vessel's position on screen.

1. Select MENU → GPS/DATA → SETTING → LL DISPLY.
2. Select ON or OFF as required.

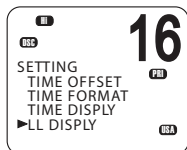
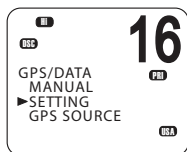

Course and speed display options

If position and time are being updated through a GPS navigation receiver, you can display or hide your course over ground (COG) and speed over ground (SOG) data on screen.

1. Select MENU → GPS/DATA → SETTING → COG/SOG.
2. Select ON or OFF as required.

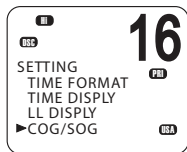
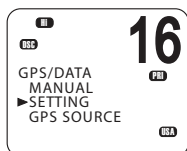

GPS alert options

If the GPS Alert setting is ON and no GPS signal is received for a period of 10 minutes, the alarm will sound for 2 minutes.

1. Select MENU → GPS/DATA → SETTING → GPS ALERT.
 2. Select ON or OFF as required.
- **Note:** The default setting is ON for the RS90S EU and OFF for the RS90S US.

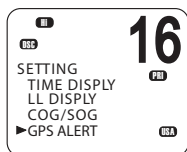
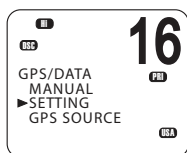

General setup

Radio sensitivity

LOCAL/DIST allows you to set the sensitivity of the radio as follows:

- LOCAL
Recommended for use in areas of high radio noise; for example, close to cities. It is not recommended for open sea conditions. Local is displayed on the handset screen.
- DISTANT
Recommended for open sea conditions.

1. Select MENU → LOCAL/DIST.
 2. Scroll to DISTANT or LOCAL as required.
 3. Press [OK].
- **Note:** See also “Adjusting squelch” on page 22.

Display contrast level

Select MENU → CONTRAST.

1. Use the ▲ or ▼ keys to raise or lower the contrast.
2. Press [OK] to accept the setting.

GPS simulator

The GPS simulator creates GPS data for test purposes.

1. Select MENU → GPS SIM.
2. Select ON or OFF as required.

→ **Notes:**

- The GPS simulator is set to OFF whenever the radio is turned on or whenever real GPS data is available through the COM port.
- The radio will be blocked from sending DSC calls while the GPS simulator is on.

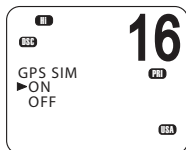
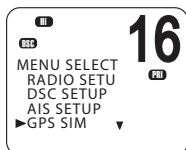
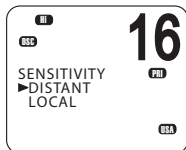
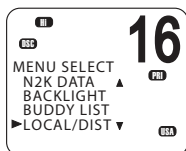

Reset to factory defaults

This option returns every setting in the RS90S to factory default values.

However, MMSI settings and entries in your buddy list are preserved.

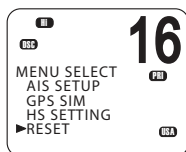

1. Select MENU → RESET.
2. Select YES to confirm and reset the radio, or NO to exit without resetting.

Backlight level

This option sets the brightness of the LCD screen and keypad.

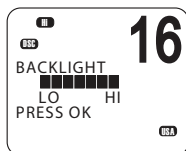
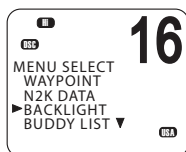

1. Select MENU → BACKLIGHT → LEVEL.
2. Use the ▲ and ▼ keys to set the level required.
3. Press [OK] to enable the setting and return to the menu.

→ Notes:

- The DISTRESS key backlight cannot be turned down.
- If the backlight setting is set to level 0 (off), the backlight will automatically turn ON at level 1 if the radio detects any DSC activity, or any buttons are pressed. The backlight will return to level 0 (off) after 10 seconds of inactivity.

9

Appendices

Appendix 1 - Troubleshooting

1. The radio will not power up.

A fuse may have blown or there is no voltage getting to the transceiver.

Check the power cable for cuts, breaks, or squashed sections.

After checking the wiring, replace the 10 Amp fuse.

Check the battery voltage. This must be at least 10.5V.
2. The transceiver blows the fuse when the power is switched on.

The power wires may have been reversed.

Check that the red wire is connected to the positive battery terminal, and the black wire is connected to the negative battery terminal.
3. The speaker makes popping or whining noises when the vessel's engine is running.

Electrical noise may be interfering with the transceiver.

Re-route the power cables away from the engine.

Add a noise suppressor to the power cable.

Use resistive spark plug wires and/or use an alternator whine filter.
4. No sound from the external speaker.

Check that the external speaker is enabled in Setup. See "External speaker" on page 90.

Check that the external speaker cable is physically connected.

Check the soldering of the external speaker cable.
5. Transmissions are always on low power, even when high (Hi) power is selected.

The antenna may be faulty.

Test the transceiver with a different antenna.

Have the antenna checked out.

6. Battery symbol is displayed.

The power supply is too low.

Check the battery voltage. This should be at least 10.5 V ± 0.5 V DC.

Check the alternator on the vessel.

7. GPS alarm sounds and LCD shows: Please check GPS link! The NO GPS symbol is shown.

GPS data has been lost. This sequence will repeat every 4 hours until GPS data from an operational GPS receiver is available. The GPS cable may faulty or the GPS setting may be incorrect:

Check that the GPS cable is physically connected.

Check the polarity of the GPS cable.

Check the baud rate setting of the GPS if applicable. The baud rate setting should be 4800. Parity should be set to NONE.

Appendix 2 - Keys reference

Key	Reference
VOL	The volume control is on the side of RS90S handset. This key also adjusts the volume of an external speaker, if connected.
16/9	Press [16/9] to immediately switch to the priority channel. Press again to return to your original channel. The default Priority Channel is CH16. In the USA, you can toggle between Channel 16 and Channel 9 as the priority channel. Hold down [16/9] until a beep sounds and the required priority channel is displayed.
DISTRESS	The red [DISTRESS] key on top of the handset sends a DSC distress call. DSC must be switched on and an MMSI must have been entered into the radio. For more information, see "Introduction to DSC" on page 40.
PTT	The Push to Talk (PTT) key enables the microphone and transmits your voice over the selected channel, see "PTT Key" on page 23.
OK	This key has multiple functions depending on the operation you are doing: Sets the high/low transmission power. The Hi or Lo icon on the display changes. In menus, press to confirm the selection.
▲ and ▼	Used for changing channel and for scrolling through menu options.
◀ and ▶	Used for adjusting squelch and moving the cursor when entering data on a wired handset.

X - Exit	When navigating menus, use [X] to clear incorrect entries, exit from a menu without saving changes, or go back to the previous screen.
CALL/ MENU	Short press to enter the DSC CALL menu and make DSC calls. See “Introduction to DSC” on page 40. Long press and hold to display the main menu. See “Using the menus” on page 23.
WX	<u>US models</u> In USA and Canadian waters, short press [WX] to hear the most recently selected weather station. For further information, see “Receiving weather alerts (US model only)” on page 27. <u>For all other models</u> The [WX] key can be programmed to a channel of your choice. For further information see “Favourite channel (non-US models)” on page 28.
NAV	Hold down for about 1 second to enter Navigation mode, which displays information about a destination waypoint on the standby screen, see “Navigating to a waypoint” on page 38.
3CH	Press to toggle between your three favourite channels, see page 29. Also used to zoom in the PPI screen, see page 64.
SCAN	See “Scanning channels” on page 29. The SCAN key is also used as the button for a softkey in DSC mode, see “Softkeys” on page 41. Also used to zoom out the PPI screen, see page 64.
AIS	Press to enter AIS mode. For AIS functionality, see “AIS procedures” on page 63. For AIS setup, see “AIS Setup” on page 102.
IC	Hold down [AIS/IC] until the Hailer menu appears, see “Using the intercom” on page 34.

Alphanumeric keys are used for entering numbers and names. (Wired handset only).

Appendix 3 - Beep tones and call alerts

Name	Description
Error	2 short beeps
Acknowledge	1 long beep
Alarm	Two-tone ring; repeated for 2 minutes or until any key is pressed
LL position call alert	Friendly 5-tone ring sequence; press [SILENC] to cancel
WX alert/SAME alert	Ear-catching multi-tone sequence
ROUTINE call alert	Friendly 5-tone ring sequence; press [SILENC] to cancel
URGENCY call alert	Two-tone ring; repeated for 2 minutes or until [SILENC] pressed
SAFETY call alert	Two-tone ring; repeated for 2 minutes or until [SILENC] pressed
DISTRESS call alert	Two-tone ring; repeated for 2 minutes or until [SILENC] pressed

Appendix 4 - Warning Messages

Warning	Message
<i>GPS DATA LOST!!</i>	The GPS signal has been lost. The connection may be broken.
<i>DSC FUNCTION DISABLED ENABLE IN SETUP</i>	The DSC function is disabled. For further information, see “Enabling DSC functionality” on page 98.
<i>ATIS MODE DISABLE SCAN</i>	Scan is automatically disabled in ATIS mode. For further information, see “ATIS” on page 62
<i>EXCESSIVE VOLTAGE!!!</i>	This warning will be displayed if the input voltage to the transceiver exceeds 16 V.

Appendix 5 - AIS information

There are several types of AIS devices as follows:

Class A transceivers

Class A transceivers are similar to class B transceivers, but they are designed to be fitted on large vessels such as cargo ships and large passenger vessels. Class A transceivers transmit at a higher VHF signal power than class B transceivers and therefore can be received by more distant vessels, and also transmit more frequently. Class A transceivers are mandatory on all vessels over 300 gross tonnes on international voyages and certain types of passenger vessels under the international Safety of Life at Sea (SOLAS) regulations.

Class B transceivers

Similar to class A transceivers in many ways, but are normally lower cost due to the less stringent performance requirements. Class B transceivers transmit at a lower power and at a lower reporting rate than class A transceivers.

AIS transceivers

AIS transceivers are used by Vessel Traffic Systems to monitor and control the transmissions of AIS transceivers.

Aids to Navigation (AtoN) transceivers

AtoN transceivers are mounted on buoys or other hazards to shipping in order to transmit details of their location to the surrounding vessels.

The RS90S VHF radio includes an AIS receiver-only function.

AIS Static and dynamic information

Defined transmit rates for Class A vessels shown below are provided for reference purposes only. The frequency of messages received vary due to a number of factors including but not limited to such factors as antenna height, gain and signal interference.

Static information is either broadcast every 6 minutes, when data has been amended, or upon request.

Dynamic information is broadcast depending on speed and course alteration based on the following tables:

Ship's dynamic conditions	Normal reporting interval
At anchor or moored	3 Minutes
0-14 knots	10 Seconds
0-14 knots and changing course	3 1/3 Seconds
14-23 knots	6 Seconds
14-23 knots and changing course	2 Seconds
Ship faster than 23 knots	2 Seconds
Ship faster than 23 knots and changing course	2 Seconds
Platform's condition	Normal reporting interval
Class B Shipborne mobile equipment not moving faster than 2 Knots	3 Minutes
Class B Shipborne mobile equipment moving 2-14 Knots	30 Seconds
Class B Shipborne mobile equipment moving 14-23 Knots	15 Seconds
Class B Shipborne mobile equipment moving faster than 23 Knots	5 Seconds
Search and Rescue aircraft (airborne mobile equipment)	10 Seconds
Aids to Navigation	3 Minutes
AIS transceiver	10 Seconds

Source of information for above table 1-1, 1-2: (ITU recommendations technical document: ITU-R M.1371-1)

Appendix 6 - Technical specification

General

Standard operation temperature	-20°C to +55°C (-4°F to 131°F)
Normal working voltage	12 VDC (10.8 to 15.6 VDC) battery system (negative ground)
Low battery detect voltage	10.5 V
Rx current drain at max audio power	≤1.5 A (one station only)
	Stand-by ≤0.35 A
	Hailer power ≤4 A
Tx current drain	Hi power ≤6 A (@13.6 VDC)
	Lo power ≤1.5 A (@13.6 VDC)
Dimensions	211.2 x 195.7 x 65.0 mm
Weight of transceiver	1.55 kg
VHF frequency range	Transmit 156.025 to 157.425 MHz (default)
	Receive 156.025 to 163.275 MHz (default)
Modulation	FM (16K0G3E) DSC (16K0G2B)
Usable channels	International, USA, Canada, Weather (country specific)
Channel spacing	25 KHz
Frequency stability	±5 PPM
Digital Selectivity Calling (DSC)	Class-D (EN301025) with dual receiver (individual CH70)
DSC standards	ITU-R M.493-13 (US models), EN 300-338-3 (EU models)
AIS standards	ITU-R M.1371-4
Other standards	EN 60950-1:2006 /A1:2010
LCD display	128 x 256 pixel LCD FSTN – 1.3" x 2.6"
Contrast control	Yes
Dimming control	Yes; can be dimmed to no backlight
Antenna connector	SO-239 (50 ohm)
NMEA 2000 connector	Micro-C (5 pin)
Waterproof	JIS-7 (totally submersible)
Compass safe distance	0.5 m (1.5')

Receiver

Intermediate frequency	1st 21.4 MHz
	2nd 450 KHz
Sensitivity	12dB SINAD dBuV \leq -6 BuV
Squelch sensitivity	\leq -4 dBuV
Spurious response rejection ratio	\geq 70 dB
Adjacent channel selectivity	\geq 70 dB
Intermodulation response	\geq 68 dB
S/N at 3KHz deviation	\geq 40 dB
Audio output power at THD 10%	5W (external speaker output)
	0.5 W handset
Audio distortion	\leq 5%
Audio response	+1 to -3 dB of 6 dB/octave from 300 Hz to 3 kHz

Transmitter

Frequency error	\pm 5 PPM
RF power	Hi: 23 ± 2 W
	Lo: 0.8 ± 0.2 W
Maximum deviation	± 5 KHz
S/N at 3 KHz deviation	40 dB
Modulation distortion \pm 3 KHz	\leq 5%
Audio response at 1KHz deviation	+1 to -3 dB of 6 dB/octave from 300 Hz to 3 kHz
Spurious/harmonic emissions	Hi/Lo <0.25 uW
Modulation sensitivity	\leq 20 mV
Transmitter protection	Open/short circuit of antenna

Communications

Comm. port NMEA 0183	NMEA 0183, 4800 baud
Comm. port NMEA 2000	NMEA 2000
NMEA 0183 input (receive)	RMC, GGA, GLL, GNS
NMEA 0183 output (transmit)	DSC (for DSC call), DSE (for enhanced position). AIVDM (AIS) 38400 Baud

Hailer

Audio power out	30 W @ 4 Ohms
-----------------	---------------

AIS

AIS function	Dual receivers only
Receiver frequency	CH87 - 161.975 MHz
	CH88 - 162.025 MHz (default channel)
Supported AIS Information	Status/Destination/ETA, Vessel Name, Type of vessel, Call sign, MMSI number, IMO number, Draft/Size of vessel, Vessel position, SOG/COG/Rate of turn/Heading

HS90 wireless handset

Rx Frequency	2401~2480 MHz
Rx channel number	80
Rx Sensitivity @ PER <=1%	-92 dBm
Rx current	<60 mA
Nominal transmit power/peak power	18+/-2 dBm
Tx frequency error	<+/-30 ppm
Tx current	<150 mA
Functional range	200 m
HS90 cradle voltage	12 VDC battery system (negative ground)
HS90 cradle current drain	≤0.5 A
Handset battery	Lithium Polymer, 7.4 V, 1500 mAh (11.1 Wh)
Handset charging method	Inductive charging built into cradle

Built-in GPS receiver

Receiving frequency	1575.42 MHz
Tracking code	C/A code
Number of channels	72 channels
Horizontal accuracy	<10 m
Position fixing time	Warm start: 30s / Cold start: 90s
Position update interval	1 second typical

→ **Note:** Specifications are subject to change without notice.

RS90S NMEA 2000 PGNS

- 126992 System Time
- 127250 Vessel Heading
- 127258 Magnetic Variation
- 129025 Position, Rapid Update
- 129026 COG & SOG, Rapid Update
- 129029 GNSS Position Data
- 129033 Time & Date
- 129038 Class A position report (Rx,Tx)
- 129039 Class B position report (Rx,Tx)
- 129040 Class B extended position report (Rx, Tx)
- 129041 AIS Aids to Navigation (AtoN) Report
- 129283 Cross Track Error
- 129284 Navigation Data
- 129285 Navigation Route/WP Information
- 129539 GNSS DOPs
- 129540 GNSS Sats in View
- 129792 DGNS Broadcast binary message (Tx)
- 129793 UTC and date report (Tx)
- 129794 Class A static and voyage related data (rx, tx)
- 129795 Addressed binary message (tx)
- 129796 Acknowledge (tx)
- 129797 Binary broadcast message (tx)
- 129798 SAR Aircraft Position report (tx)
- 129799 Radio Frequency/Mode/Power
- 129800 UTC/Date enquiry (tx)
- 129801 Addressed safety msg (rx,tx)
- 129802 Broadcast safety msg (rx,tx)
- 129803 Interrogation (tx)
- 129804 Assignment Mode Command (tx)
- 129805 Data Link Management message (tx)
- 129807 AIS Group Assignment
- 129808 DSC Call Information
- 129809 AIS Class B "CS" Static Data Report, Part A
- 129810 AIS Class B "CS" Static Data Report, Part B
- 130074 Route and WP Service - WP List - WP Name & Position
- 130840 Source Selection
- 130842 AIS and VHF Messages (Simrad Proprietary for AIS Class B 'CS')
- 130850 Event Command

Appendix 7 - Channel charts

The following channel charts are provided for reference only and may not be correct for all regions. It is the operator's responsibility to ensure correct channels and frequencies are used for local regulations.

EU and INTERNATIONAL channel chart

The following is a table of transmitting frequencies in the VHF maritime mobile band.

- **Note:** For assistance in understanding the Table, see Notes a) to zz) below. (WRC-15)
- **Note:** The Table below defines the channel numbering for maritime VHF communications based on 25 kHz channel spacing and use of several duplex channels. The channel numbering and the conversion of two-frequency channels for single-frequency operation shall be in accordance with Recommendation ITU-R M.1084-5 Annex 4, Tables 1 and 3. The Table below also describes the harmonized channels where the digital technologies defined in the most recent version of Recommendation ITU-R M.1842 could be deployed. (WRC-15)

Channel designator	Transmitting frequencies (MHz)					
	From ship stations	From coast stations	S/D/R	Channel name	Restriction	Notes
01	156.050	160.650	D	TELEPHONE		m)
02	156.100	160.700	D	TELEPHONE		m)
03	156.150	160.750	D	TELEPHONE		m)
04	156.200	160.800	D	PORT OPS		m)
05	156.250	160.850	D	PORT OPS/VTS		m)
06	156.300	156.300	S	SAFETY		f)
07	156.350	160.950	D	PORT OPS		m)
08	156.400	156.400	S	COMMERCIAL		
09	156.450	156.450	S	CALLING		i)
10	156.500	156.500	S	COMMERCIAL		h), q)
11	156.550	156.550	S	VTS		q)
12	156.600	156.600	S	PORT OPS/VTS		
13	156.650	156.650	S	BRIDGE COM		k)
14	156.700	156.700	S	PORT OPS/VTS		
15	156.750	156.750	S	PORT OPS	1W	g)
16	156.800	156.800	S	DISTRESS		f)
17	156.850	156.850	S	SAR	1W	g)

18	156.900	161.500	D	PORT OPS		m)
19	156.950	161.550	D	SHIP-SHORE		t), u), v)
20	157.000	161.600	D	PORT OPS		t), u), v)
21	157.050	161.650	D	PORT OPS		w), y)
22	157.100	161.700	D	PORT OPS		w), y)
23	157.150	161.750	D	TELEPHONE		w), x), y)
24	157.200	161.800	D	TELEPHONE		w), ww), x), y)
25	157.250	161.850	D	TELEPHONE		w), ww), x), y)
26	157.300	161.900	D	TELEPHONE		w), ww), x), y)
27	157.350	161.950	D	TELEPHONE		z)
28	157.400	162.000	D	TELEPHONE		z)
60	156.025	160.625	D	TELEPHONE		m)
61	156.075	160.675	D	PORT OPS		m)
62	156.125	160.725	D	PORT OPS		m)
63	156.175	160.775	D	PORT OPS		m)
64	156.225	160.825	D	TELEPHONE		m)
65	156.275	160.875	D	PORT OPS		m)
66	156.325	160.925	D	PORT OPS		m)
67	156.375	156.375	S	BRIDGE COM		h)
68	156.425	156.425	S	SHIP-SHIP		
69	156.475	156.475	S	PORT OPS		
71	156.575	156.575	S	PORT OPS		
72	156.625	156.625	S	SHIP-SHIP		i)
73	156.675	156.675	S	PORT OPS		h), i)
74	156.725	156.725	S	PORT OPS		
75	156.775	156.775	S	PORT OPS	1W	n), s)
76	156.825	156.825	S	SHIP-SHIP	1W	n), s)
77	156.875	156.875	S	SHIP-SHIP		
78	156.925	161.525	D	SHIP-SHORE		t), u), v)
79	156.975	161.575	D	PORT OPS		t), u), v)
80	157.025	161.625	D	PORT OPS		w), y)
81	157.075	161.675	D	TELEPHONE		w), y)
82	157.125	161.725	D	TELEPHONE		w), x), y)
83	157.175	161.775	D	TELEPHONE		w), x), y)
84	157.225	161.825	D	TELEPHONE		w), ww), x), y)
85	157.275	161.875	D	TELEPHONE		w), ww), x), y)
86	157.325	161.925	D	TELEPHONE		w), ww), x), y)
87	157.375	157.375	S	TELEPHONE		z)
88	157.425	157.425	S	TELEPHONE		z)
1019	156.950	156.950	S	TELEPHONE		
1020	157.000	157.000	S	TELEPHONE		
1078	156.925	156.925	S	TELEPHONE		
1079	156.975	156.975	S	TELEPHONE		
2006	160.900	160.900	S	TELEPHONE		r)
2019	161.550	161.550	S	TELEPHONE		

2020	161.600	161.600	S	TELEPHONE		
2078	161.525	161.525	S	TELEPHONE		
2079	161.575	161.575	S	TELEPHONE		

Editorial note: The note numbering below is provisional and will be aligned during final preparations of the new edition of the Radio Regulations.

Notes referring to the Table

General notes:

- a) Administrations may designate frequencies in the inter-ship, port operations and ship movement services for use by light aircraft and helicopters to communicate with ships or participating coast stations in predominantly maritime support operations under the conditions specified in Nos. **51.69, 51.73, 51.74, 51.75, 51.76, 51.77** and **51.78**. However, the use of the channels which are shared with public correspondence shall be subject to prior agreement between interested and affected administrations.
- b) The channels of the present Appendix, with the exception of channels 06, 13, 15, 16, 17, 70, 75 and 76, may also be used for high-speed data and facsimile transmissions, subject to special arrangement between interested and affected administrations.
- c) The channels of the present Appendix, with the exception of channels 06, 13, 15, 16, 17, 70, 75 and 76, may be used for direct-printing telegraphy and data transmission, subject to special arrangement between interested and affected administrations. (WRC-12)
- d) The frequencies in this table may also be used for radio communications on inland waterways in accordance with the conditions specified in No. **5.226**.
- e) Administrations may apply 12.5 kHz channel interleaving on a non-interference basis to 25 kHz channels, in accordance with the most recent version of Recommendation ITU-R M.1084, provided:
 - it shall not affect the 25 kHz channels of the present Appendix maritime mobile distress and safety, automatic identification system (AIS), and data exchange frequencies, especially the channels 06, 13, 15, 16, 17, 70, AIS 1 and AIS 2, nor the technical characteristics set forth in Recommendation ITU-R M.489-2 for those channels;

- implementation of 12.5 kHz channel interleaving and consequential national requirements shall be subject to coordination with affected administrations. (WRC-12)

Specific notes

- f) The frequencies 156.300 MHz (channel 06), 156.525 MHz (channel 70), 156.800 MHz (channel 16), 161.975 MHz (AIS 1) and 162.025 MHz (AIS 2) may also be used by aircraft stations for the purpose of search and rescue operations and other safety-related communication. (WRC-07)
- g) Channels 15 and 17 may also be used for on-board communications provided the effective radiated power does not exceed 1W, and subject to the national regulations of the administration concerned when these channels are used in its territorial waters.
- h) Within the European Maritime Area and in Canada, these frequencies (channels 10, 67, 73) may also be used, if so required, by the individual administrations concerned, for communication between ship stations, aircraft stations and participating land stations engaged in coordinated search and rescue and anti-pollution operations in local areas, under the conditions specified in Nos. **51.69, 51.73, 51.74, 51.75, 51.76, 51.77** and **51.78**.
- i) The preferred first three frequencies for the purpose indicated in Note **a)** are 156.450 MHz (channel 09), 156.625 MHz (channel 72) and 156.675 MHz (channel 73).
- j) Channel 70 is to be used exclusively for digital selective calling for distress, safety and calling.
- k) Channel 13 is designated for use on a worldwide basis as a navigation safety communication channel, primarily for intership navigation safety communications. It may also be used for the ship movement and port operations service subject to the national regulations of the administrations concerned.
- l) These channels (AIS 1 and AIS 2) are used for an automatic identification system (AIS) capable of providing world wide operation, unless other frequencies are designated on a regional basis for this purpose. Such use should be in accordance with the most recent version of Recommendation ITU-RM.1371. (WRC-07)
- m) These channels may be operated as single frequency channels, subject to coordination with affected administrations. The following conditions apply for single frequency usage:

- The lower frequency portion of these channels may be operated as single frequency channels by ship and coast stations.
- Transmission using the upper frequency portion of these channels is limited to coast stations.
- If permitted by administrations and specified by national regulations, the upper frequency portion of these channels may be used by ship stations for transmission. All precautions should be taken to avoid harmful interference to channels AIS 1, AIS 2, 2027* and 2028*. (WRC-15)

* From 1 January 2019, channel 2027 will be designated ASM 1 and channel 2028 will be designated ASM 2.

- n) With the exception of AIS, the use of these channels (75 and 76) should be restricted to navigation-related communications only and all precautions should be taken to avoid harmful interference to channel 16, by limiting the output power to 1W. (WRC-12)
- o) (SUP - WRC-12)
- p) Additionally, AIS 1 and AIS 2 may be used by the mobile-satellite service (Earth-to-space) for the reception of AIS transmissions from ships. (WRC-07)
- q) When using these channels (10 and 11), all precautions should be taken to avoid harmful interference to channel 70. (WRC-07) In the maritime mobile service, this frequency is reserved for experimental use for future applications or systems (e.g. new AIS applications, man over board systems, etc.). If authorized by administrations for experimental use, the operation shall not cause harmful interference to, or claim protection from, stations operating in the fixed and mobile services. (WRC-12)
- r) Channels 75 and 76 are also allocated to the mobile-satellite service (Earth-to-space) for the reception of long-range AIS broadcast messages from ships (Message 27; see the most recent version of Recommendation ITU-RM.1371). (WRC-12)
- w. In Regions 1 and 3:

Until 1 January 2017, the frequency bands 157.200-157.325 MHz and 161.800-161.925 MHz (corresponding to channels: 24, 84, 25, 85, 26 and 86) may be used for digitally modulated emissions, subject to coordination with affected administrations. Stations using these channels or frequency bands for digitally modulated emissions shall not cause harmful interference to, or claim protection from, other stations operating in accordance with Article 5.

From 1 January 2017, the frequency bands 157.200-157.325 MHz and 161.800-161.925 MHz (corresponding to channels: 24, 84, 25, 85, 26 and 86) are identified for the utilization of the VHF Data Exchange System (VDES) described in the most recent version of Recommendation ITU-R M.2092. These frequency bands may also be used for analogue modulation described in the most recent version of Recommendation ITU-R M.1084 by an administration that wishes to do so, subject to not causing harmful interference to, or claiming protection from other stations in the maritime mobile service using digitally modulated emissions and subject to coordination with affected administrations. (WRC-15)

- ww. In Region 2, the frequency bands 157.200-157.325 and 161.800-161.925 MHz (corresponding to channels: 24, 84, 25, 85, 26 and 86) are designated for digitally modulated emissions in accordance with the most recent version of Recommendation ITU-R M.1842.

In Canada and Barbados, from 1 January 2019 the frequency bands 157.200-157.275 and 161.800-161.875 MHz (corresponding to channels: 24, 84, 25 and 85) may be used for digitally modulated emissions, such as those described in the most recent version of Recommendation ITU-R M.2092, subject to coordination with affected administrations. (WRC-15)

- x) From 1 January 2017, in Angola, Botswana, Lesotho, Madagascar, Malawi, Mauritius, Mozambique, Namibia, Democratic Republic of the Congo, Seychelles, South Africa, Swaziland, Tanzania, Zambia and Zimbabwe, the frequency bands 157.125-157.325 and 161.725-161.925 MHz (corresponding to channels: 82, 23, 83, 24, 84, 25, 85, 26 and 86) are designated for digitally modulated emissions.

From 1 January 2017, in China, the frequency bands 157.150 - 157.325 and 161.750 - 161.925 MHz (corresponding to channels: 23, 83, 24, 84, 25, 85, 26 and 86) are designated for digitally modulated emissions. (WRC-12)

- y) These channels may be operated as single or duplex frequency channels, subject to coordination with affected administrations. (WRC-12)
- z) Until 1 January 2019, these channels maybe used for possible testing of future AIS applications without causing harmful interference to, or claiming protection from, existing applications and stations operating in the fixed and mobile services.

From 1 January 2019, these channels are each split into two simplex channels. The channels 2027 and 2028 designated as ASM 1 and ASM 2 are used for application specific messages (ASM) as described in the most recent version of Recommendation ITU-R M.2092. (WRC-15)

AAA) From 1 January 2019, the channels 24, 84, 25 and 85 may be merged in order to form a unique duplex channel with a bandwidth of 100 kHz in order to operate the VDES terrestrial component described in the most recent version of Recommendation ITU-R M.2092. (WRC-15)

mm) Transmission on these channels is limited to coast stations. If permitted by administrations and specified by national regulations, these channels may be used by ship stations for transmission. All precautions should be taken to avoid harmful interference to channels AIS 1, AIS 2, 2027* and 2028*. (WRC-15)

* From 1 January 2019, channel 2027 will be designated ASM 1 and channel 2028 will be designated ASM 2.

w1) In Regions 1 and 3:

Until 1 January 2017, the frequency bands 157.025-157.175 MHz and 161.625-161.775 MHz (corresponding to channels: 80, 21, 81, 22, 82, 23 and 83) may be used for digitally modulated emissions, subject to coordination with affected administrations. Stations using these channels or frequency bands for digitally modulated emissions shall not cause harmful interference to, or claim protection from, other stations operating in accordance with Article 5.

From 1 January 2017, the frequency bands 157.025-157.100 MHz and 161.625-161.700 MHz (corresponding to channels: 80, 21, 81 and 22) are identified for utilization of the digital systems described in the most recent version of Recommendation ITU-R M.1842 using multiple 25 kHz contiguous channels.

From 1 January 2017, the frequency bands 157.150-157.175 MHz and 161.750-161.775 MHz (corresponding to channels: 23 and 83) are identified for utilization of the digital systems described in the most recent version of Recommendation ITU-R M.1842 using two 25 kHz contiguous channels. From 1 January 2017, the frequencies 157.125 MHz and 161.725 MHz (corresponding to channel: 82) are identified for the utilization of the digital systems described in the most recent version of Recommendation ITU-R M.1842.

The frequency bands 157.025-157.175 MHz and 161.625-161.775 MHz (corresponding to channels: 80, 21, 81, 22, 82, 23 and 83) can also be used for analogue modulation described in the most recent version of Recommendation ITU-R M.1084 by an administration that wishes to do so, subject to not claiming protection from other stations in the maritime mobile service using digitally modulated emissions and subject to coordination with affected administrations. (WRC-15)

- zx) In the United States, these channels are used for communication between ship stations and coast stations for the purpose of public correspondence. (WRC-15)
- zz) From 1 January 2019, channels 1027, 1028, 87 and 88 are used as single-frequency analogue channels for port operation and ship movement. (WRC-15)

Source: ITU Radio Regulations (2016); reproduced with permission from ITU

USA channel chart

Channel designator	Transmitting frequencies (MHz)		S/D/R	Channel name	Restrictions
	From ship stations	From coast stations			
6	156.300	156.300	S	SAFETY	
8	156.400	156.400	S	COMMERCIAL	
9	156.450	156.450	S	CALLING	
10	156.500	156.500	S	COMMERCIAL	
11	156.550	156.550	S	VTS	
12	156.600	156.600	S	PORT OPS/VTS	
13	156.650	156.650	S	BRIDGE COM	1W
14	156.700	156.700	S	PORT OPS/VTS	
15	--	156.750	R	ENVIRONMENTAL	RX ONLY
16	156.800	156.800	S	DISTRESS	
17	156.850	156.850	S	SAR	1W
20	157.000	161.600	D	PORT OPS	
24	157.200	161.800	D	TELEPHONE	
25	157.250	161.850	D	TELEPHONE	
26	157.300	161.900	D	TELEPHONE	
27	157.350	161.950	D	TELEPHONE	
28	157.400	162.000	D	TELEPHONE	
67	156.375	156.375	S	BRIDGE COM	1W
68	156.425	156.425	S	SHIP-SHIP	
69	156.475	156.475	S	SHIP-SHIP	
71	156.575	156.575	S	SHIP-SHIP	
72	156.625	156.625	S	SHIP-SHIP	
73	156.675	156.675	S	PORT OPS	
74	156.725	156.725	S	PORT OPS	
75	156.775	156.775	S	PORT OPS	1W
76	156.825	156.825	S	PORT OPS	1W
77	156.875	156.875	S	PORT OPS	1W
84	157.225	161.825	D	TELEPHONE	
85	157.275	161.875	D	TELEPHONE	
86	157.325	161.925	D	TELEPHONE	
87	157.375	157.375	S	TELEPHONE	
88	157.425	157.425	S	INTER-SHIP	
1001	156.050	156.050	S	PORT OPS/VTS	
1005	156.250	156.250	S	PORT OPS/VTS	

1007	156.350	156.350	S	COMMERCIAL	
1018	156.900	156.900	S	COMMERCIAL	
1019	156.950	156.950	S	COMMERCIAL	
1020	157.000	157.000	S	PORT OPS	
1021	157.050	157.050	S	US COAST GRD	
1022	157.100	157.100	S	US COAST GRD	
1023	157.150	157.150	S	US COAST GRD	
1063	156.175	156.175	S	PORT OPS/VTS	
1065	156.275	156.275	S	PORT OPS	
1066	156.325	156.325	S	PORT OPS	
1078	156.925	156.925	S	SHIP-SHIP	
1079	156.975	156.975	S	COMMERCIAL	
1080	157.025	157.025	S	COMMERCIAL	
1081	157.075	157.075	S	RESTRICTED	
1082	157.125	157.125	S	RESTRICTED	
1083	157.175	157.175	S	RESTRICTED	

USA weather channels

Channel designator	Transmitting frequencies (MHz)		S/D/R	Channel name	Restrictions
	From ship stations	From coast stations			
WX1	---	162.550	R	NOAA WX1	RX ONLY
WX2	---	162.400	R	NOAA WX2	RX ONLY
WX3	---	162.475	R	NOAA WX3	RX ONLY
WX4	---	162.425	R	NOAA WX4	RX ONLY
WX5	---	162.450	R	NOAA WX5	RX ONLY
WX6	---	162.500	R	NOAA WX6	RX ONLY
WX7	---	162.525	R	NOAA WX7	RX ONLY

CANADA channel chart

Channel designator	Frequencies		S/D/R	Channel Name:	RESTRICTIONS
	MHz (ship)	MHz (coast)			
1	156.050	160.650	D	TELEPHONE	
2	156.100	160.700	D	TELEPHONE	
3	156.150	160.750	D	TELEPHONE	
4	156.200	160.800	D	CANADIAN CG	
5	156.250	160.850	D	TELEPHONE	
6	156.300	156.300	S	SAFETY	
7	156.350	160.950	D	TELEPHONE	
8	156.400	156.400	S	COMMERCIAL	
9	156.450	156.450	S	VTS	
10	156.500	156.500	S	VTS	
11	156.550	156.550	S	VTS	
12	156.600	156.600	S	PORT OPS/VTS	
13	156.650	156.650	S	BRIDGE COM	1W
14	156.700	156.700	S	PORT OPS/VTS	
15	156.750	156.750	S	COMMERCIAL	1W
16	156.800	156.800	S	DISTRESS	
17	156.850	156.850	S	SAR	1W
18	156.900	161.500	D	TELEPHONE	
19	156.950	161.550	D	CANADIAN CG	
20	157.000	161.600	D	CANADIAN CG	1W
21	157.050	161.650	D	CANADIAN CG	
22	157.100	161.700	D	TELEPHONE	
23	157.150	161.750	D	TELEPHONE	
24	157.200	161.800	D	TELEPHONE	
25	157.250	161.850	D	TELEPHONE	
26	157.300	161.900	D	TELEPHONE	
27	157.350	161.950	D	TELEPHONE	
28	157.400	162.000	D	TELEPHONE	
60	156.025	160.625	D	TELEPHONE	
61	156.075	160.675	D	CANADIAN CG	
62	156.125	160.725	D	CANADIAN CG	
63	156.175	160.775	D	TELEPHONE	
64	156.225	160.825	D	TELEPHONE	
65	156.275	160.875	D	TELEPHONE	

66	156.325	160.925	D	TELEPHONE	
67	156.375	156.375	S	COMMERCIAL	
68	156.425	156.425	S	SHIP-SHIP	
69	156.475	156.475	S	COMMERCIAL	
71	156.575	156.575	S	VTS	
72	156.625	156.625	S	SHIP-SHIP	
73	156.675	156.675	S	COMMERCIAL	
74	156.725	156.725	S	VTS	
75	156.775	156.775	S	PORT OPS	1W
76	156.825	156.825	S	PORT OPS	1W
77	156.875	156.875	S	PORT OPS	1W
78	156.925	161.525	D	TELEPHONE	
79	156.975	161.575	D	TELEPHONE	
80	157.025	161.625	D	TELEPHONE	
81	157.075	161.675	D	TELEPHONE	
82	157.125	161.725	D	CANADIAN CG	
83	157.175	161.775	D	CANADIAN CG	
84	157.225	161.825	D	TELEPHONE	
85	157.275	161.875	D	TELEPHONE	
86	157.325	161.925	D	TELEPHONE	
87	157.375	157.375	S	PORT OPS	
88	157.425	157.425	S	PORT OPS	
1001	156.050	156.050	S	COMMERCIAL	
1005	156.250	156.250	S	PORT OPS/VTS	
1007	156.350	156.350	S	COMMERCIAL	
1018	156.900	156.900	S	COMMERCIAL	
1019	156.950	156.950	S	CANADIAN CG	
1020	157.000	157.000	S	PORT OPS	
1021	157.050	157.050	S	RESTRICTED	
1022	157.100	157.100	S	CANADIAN CG	
1024	157.200	157.200	S	PORT OPS	
1025	157.250	157.250	S	PORT OPS	
1026	157.300	157.300	S	PORT OPS	
1027	157.350	157.350	S	CANADIAN CG	
1061	156.075	156.075	S	CANADIAN CG	
1062	156.125	156.125	S	CANADIAN CG	
1063	156.175	156.175	S	TELEPHONE	
1064	156.225	156.225	S	RESTRICTED	

1065	156.275	156.275	S	PORT OPS	
1066	156.325	156.325	S	PORT OPS	
1078	156.925	156.925	S	SHIP-SHIP	
1079	156.975	156.975	S	COMMERCIAL	
1080	157.025	157.025	S	COMMERCIAL	
1083	157.175	157.175	S	RESTRICTED	
1084	157.225	157.225	S	PORT OPS	
1085	157.275	157.275	S	CANADIAN CG	
1086	157.325	157.325	S	PORT OPS	
2019	--	161.550	R	PORT OPS	RX ONLY
2020	--	161.600	R	PORT OPS	RX ONLY
2023	--	161.750	R	SAFETY	RX ONLY
2026	--	161.900	R	PORT OPS	RX ONLY
2078	--	161.525	R	PORT OPS	RX ONLY
2079	--	161.575	R	PORT OPS	RX ONLY
2086	--	161.925	R	PORT OPS	RX ONLY

Canada weather channels

Channel designator	Transmitting frequencies (MHz)		S/D/R	Channel name	Restrictions
	From ship stations	From coast stations			
WX1	--	162.550	R	CANADA WX	Rx only
WX2	--	162.400	R	CANADA WX	Rx only
WX3	--	162.475	R	CANADA WX	Rx only

EAS (Emergency Alert Systems) alerts

National Codes Nature of Activation	Event Codes	Message
Emergency Action Notification (National only)	EAN	WARNING
	EAT	ADVISORY
National Information Center	NIC	ADVISORY
National Periodic Test	NPT	TEST
Required Monthly Test	RMT	TEST
Required Weekly Test	RWT	TEST

State and Local Codes Nature of Activation	Event Codes	Message
Avalanche Warning	AVW	WARNING
Avalanche Watch	AVA	WATCH
Blizzard Warning	BZW	WARNING
Child Abduction Emergency	CAE	WARNING
Civil Danger Warning	CDW	WARNING
Civil Emergency Message	CEM	WARNING
Coastal Flood Warning	CFW	WARNING
Coastal Flood Watch	CFA	WATCH
Dust Storm Warning	DSW	WARNING
Earthquake Warning	EQW	WARNING
Evacuation Immediate	EVI	WARNING
Fire Warning	FRW	WARNING
Flash Flood Warning	FFW	WARNING
Flash Flood Watch	FFA	WATCH
Flash Flood Statement	FFS	ADVISORY
Flood Warning	FLW	WARNING
Flood Watch	FLA	WATCH
Flood Statement	FLS	ADVISORY
Hazardous Materials Warning	HMW	WARNING
High Wind Warning	HWW	WARNING
High Wind Watch	HWA	WATCH
Hurricane Warning	HUW	WARNING
Hurricane Watch	HUA	WATCH
Hurricane Statement	HLS	ADVISORY
Law Enforcement Warning	LEW	WARNING
Local Area Emergency	LAE	WARNING
911 Telephone Outage Emergency	TOE	WARNING
Nuclear Power Plant Warning	NUW	WARNING
Radiological Hazard Warning	RHW	WARNING
Severe Thunderstorm Warning	SVR	WARNING
Severe Thunderstorm Watch	SVA	WATCH
Severe Weather Statement	SVS	ADVISORY

State and Local Codes Nature of Activation	Event Codes	Message
Shelter in Place Warning	SPW	WARNING
Special Marine Warning	SMW	WARNING
Special Weather Statement	SPS	ADVISORY
Tornado Warning	TOR	WARNING
Tornado Watch	TOA	WATCH
Tropical Storm Warning	TRW	WARNING
Tropical Storm Watch	TRA	WATCH
Tsunami Warning	TSW	WARNING
Tsunami Watch	TSA	WATCH
Volcano Warning	VOW	WARNING
Winter Storm Warning	WSW	WARNING
Winter Storm Watch	WSA	WATCH

For more information about the Emergency Alert System and event codes, visit: http://www.nws.noaa.gov/os/eas_codes.shtml Simrad

Special channels

Country	Item	Chart	Primary Channel
EU Standard, France, Greece, Spain, Portugal	DSC ON	EUR Default	
UK	DSC ON	EUR Default	M, M2
Belgium	DSC ON	EUR Default	31, 37, 96 (1W)
	ATIS ON	EUR Default	31, 96 (1W)
Norway, Finland	DSC ON		L1, L2, L3, F1, F2, F3
Sweden, Denmark	DSC ON		L1, L2, F1, F2, F3
Italy	DSC ON		
Italy (with coast)	DSC ON		A0, A1, A2, A3, A4, A5, A6, C0, C1, C2, C3, C4, C5, C6, C7, C8, C9
Holland	DSC ON		31 (1W), 37
	ATIS ON	EUR Default	31 (1W)
Germany	DSC ON		
	ATIS ON	EUR Default	
Austria	DSC ON	EUR Default	
	ATIS ON	EUR Default	

